

ultraframe

Transforming light and space

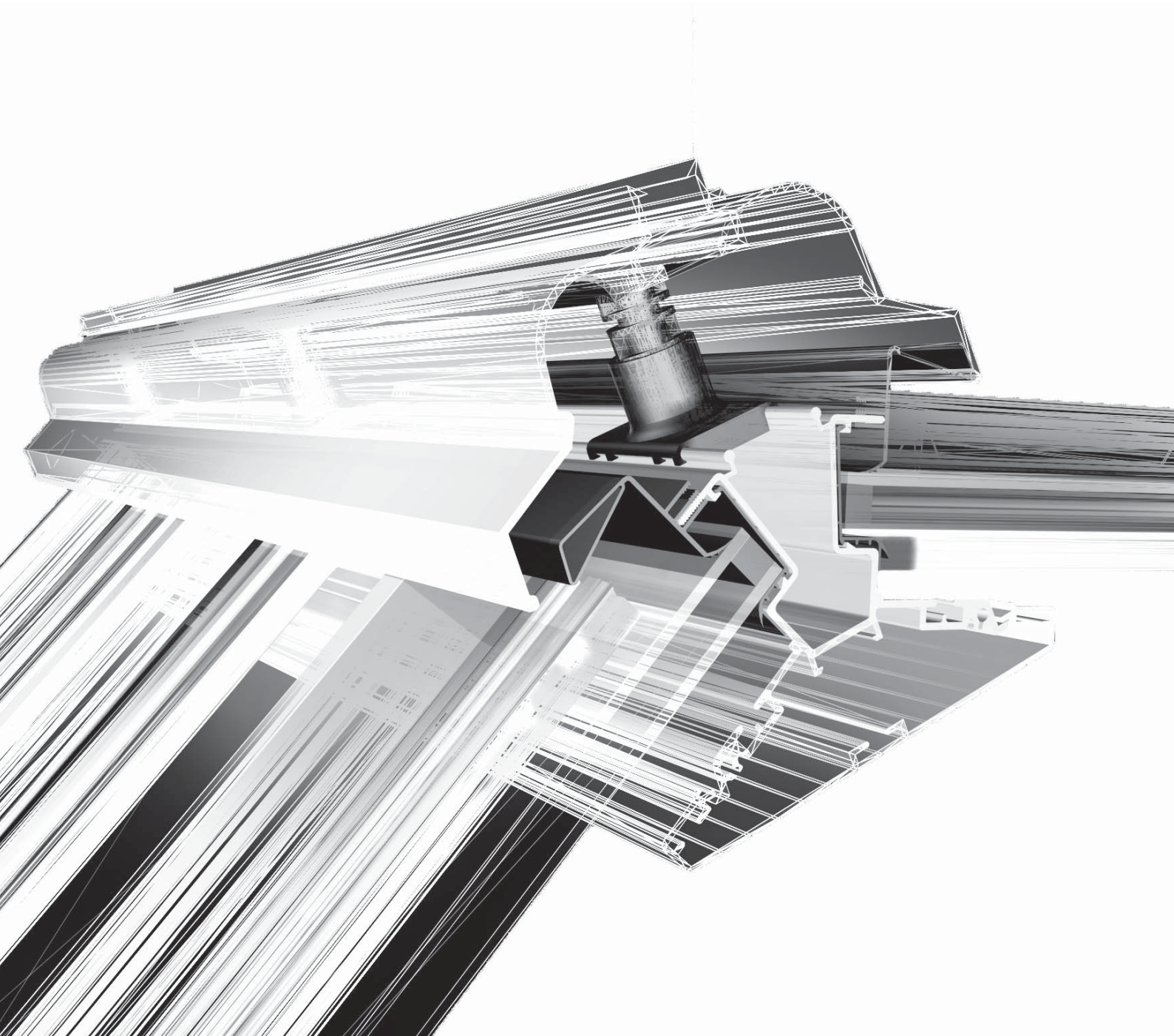

Classicroof

by ultraframe

Product Directory

Version 6 | March 2016

DIRECTORY – Overview

This guide is a 'snap shot' of the core elements of the Classic roof

SECTION 1 - Eaves

Pages 3-11

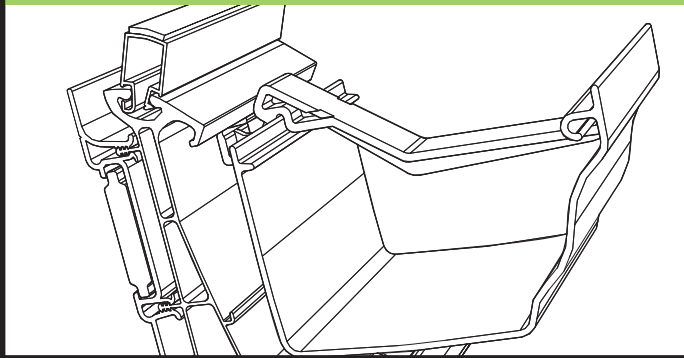

SECTION 2 - Ridge

Page 12-21

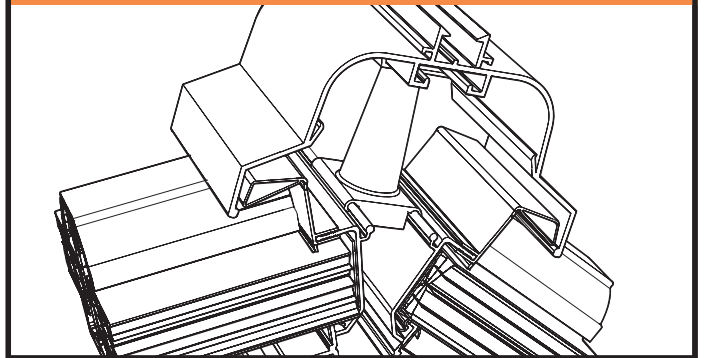

SECTION 3 - Glazing Bars

Pages 22-27

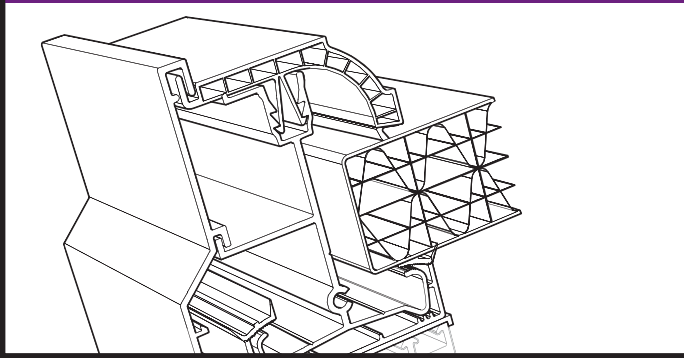

SECTION 4 - Valley

Pages 28-29

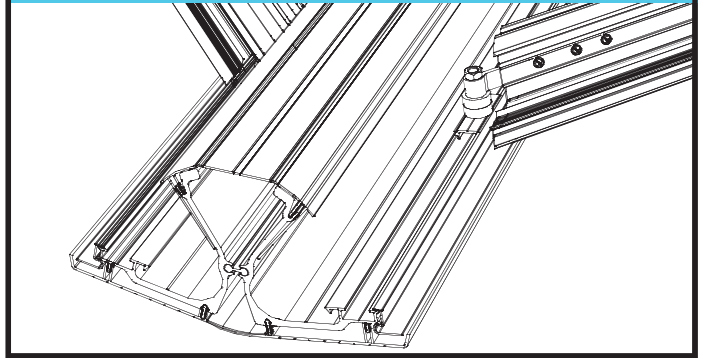

SECTION 5 - Guttering

Pages 30-35

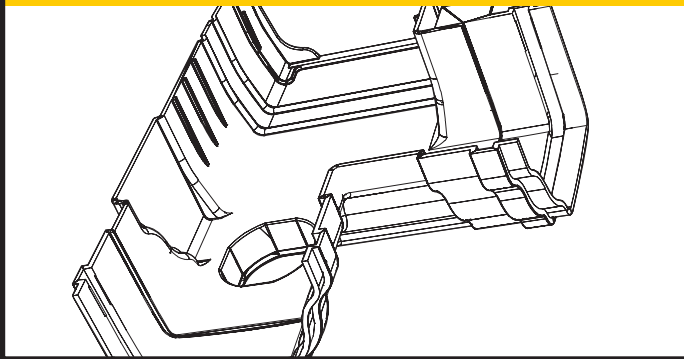

SECTION 6 - Ancillaries

Pages 36-39

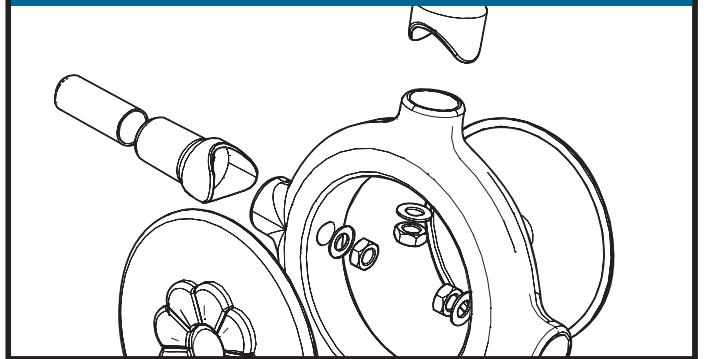

SECTION 7 - Boxgutter Adaptors

Page 40-41

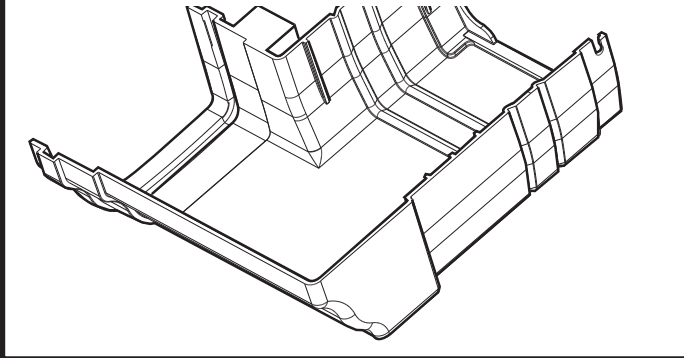

SECTION 8 - Rainwater Outlets

Page 42

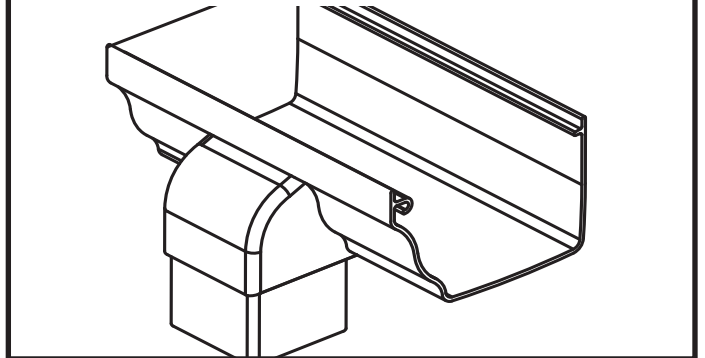

SECTION 1 - Eaves

The starting point for any roof system, as it attaches to the top of the side frames

SFB600 - Decorative ultraselect fascia

PSUB600 - Glazing support trim

VAAA600H - Heavy multi eaves beam

MGBB001 - Gutter bracket

MGU600 - Classic gutter

SFI - - Ultraselect decorative infill

See page 8 for details.

or

Plain infil SNP on p9

UGTB600 - Under gutter trim

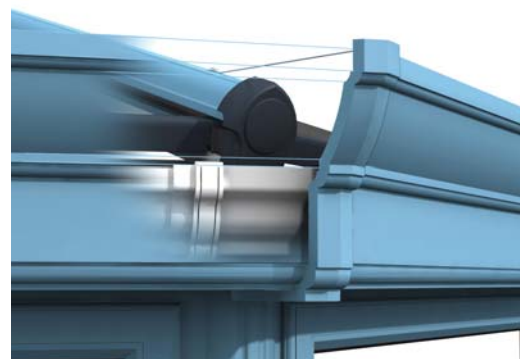

AGP - - - Glazing End Profile



AGP---/25 GLAZING END PROFILE
AGP---/25GR GLAZING END PROFILE GREY

AVBA - - - Veranda Beam



AVBA600W/1 VERANDA BEAM/ GUTTER
AVBA001 VERANDA BEAM GASKET
AVBA004 VERANDA BEAM BAR TO BEAM BRACKET
AVBA005 VERANDA BEAM GLASS CLIP BRACKET
AVBA006 BLACK VINYL END CAP
AVBA010 BLACK VINYL POST CAP

CRN - - - Cornice



CRN---/1 LOWER CORNICE SECTION (USED WITH STANDARD EAVES BEAM)
CRN---/2 MIDDLE CORNICE SECTION
CRN---/3 UPPER CORNICE SECTION
CRN001 CLEAT (CONNECTING CORNICE CORNERS)
CRN002 SUPPORT BRACKET - CORNICE GUTTER
CRN003 GABLE/ LEAN TO END PLATE- CORNICE
CRN005 TIE WIRE (USED OFF TRANSOM/ JACK)
CRN006 CLEAT SCREW M4 X 10
CRN007 SECTION SCREW 4.8 X 16
CRN008 END PLATE SCREW 3.5 X 13
CRN010 TIE WIRE SCREW
CRN012 LONG CORNER THE WIRE (HIP BARS)
CRN014 CORNICE INLINE OUTLET COVER
CRN090 90 DEGREE CORNICE COVER CORNERS
CRN135 135 DEGREE CORNICE COVER CORNERS
CRN180 180 DEGREE CORNICE COVER CORNERS

CRS 001 Lantern Header Cleat Screw

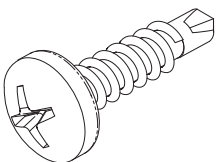

CRS001 LANTERN HEADER SCREW 4.2 X 13
(PAN HEAD SELF DRILL SCREW)

DFCA - - - Decorative Fascia Jointers/ Corners

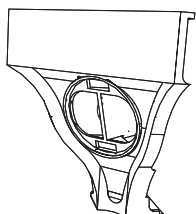

DFCA001 INLINE JOINTER
DFCA090A ADJUSTABLE CORNER
DFCA090I 90 DEGREE INTERNAL CORNER
DFCA135 135 DEGREE CORNER
DFCA150 150 DEGREE CORNER

DCM 001 Insert for Decorative Fascia Corners

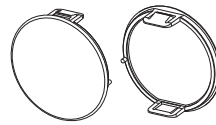

DCM001 INSERT FOR DEC FASCIA CORNERS

DFS 650/2 Trim to oe of Super Duty Eaves Beam



DFS650/2 TRIM TO TOE OF SUPER DUTY EAVES BEAM

DTA - - - Dentil add on Profile

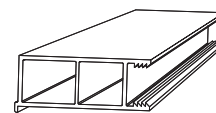

DTA600 DENTIL ADD ON 58-64MM FRAMES
DTA600L DENTIL ADD ON 65-70MM FRAMES

DTM - - - Dentil Moulding

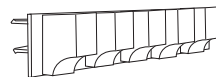

DTM002 DENTIL MOULDING CLIP FIT
DTM004 DENTIL MOULDING ADHESIVE FIX

EBCA - - - Eaves Beam Connecting Cleats

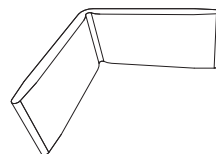

EBCA001 CLEAT INLINE
EBCA090 CLEAT 90 DEGREE
EBCA135 CLEAT 135 DEGREE
EBCA150 CLEAT 150 DEGREE

EBT 001 Eaves Beam Cleat Taptite Screw

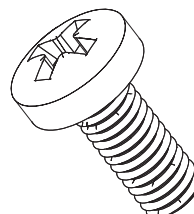

EBT001 EAVES BEAM CLEAT TAPTITE M5 x12

ECF 001 **End Cap Fixing Kit (50)**

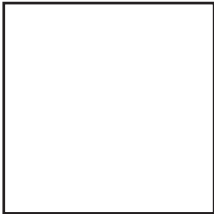

ECF001 END CAP FIXING KIT (50)

GBE - - - **Aluminium Gable Beam**

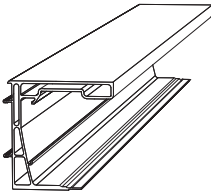

GBE400 ALUMINIUM GABLE BEAM 4M
GBE650 ALUMINIUM GABLE BEAM 6.5M

EECA - - - **Eaves Beam End Plug**

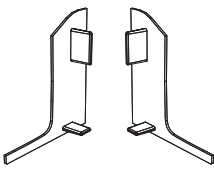

EECA001SL/R EAVES BEAM END PLUG

GBIA - - - **Gable Infill Wedge**

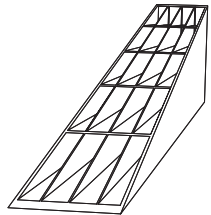

GBIA010 GABLE INFILL WEDGE - 10°
GBIA015 GABLE INFILL WEDGE - 15°
GBIA020 GABLE INFILL WEDGE - 20°
GBIA025 GABLE INFILL WEDGE - 25°
GBIA030 GABLE INFILL WEDGE - 30°

FIR - - - **Firring Top Cap (Used with LCTB)**



FIR/2NT FIRRING TOP CAP
(USED WITH LCTB)

GBR- - - **Gable Beam Reinforcement**

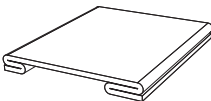

GBR500 GABLE BEAM REINFORCEMENT 5M
GBR650 GABLE BEAM REINFORCEMENT 6.5M

FLN 001 **Flange Nut (7mm Holes)**



FLN001 FLANGE NUT(7mm HOLES)

GEC - - - **Gable Beam Top Cladding**

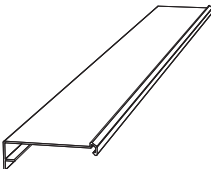

GEC650 GABLE BEAM TOP CLADDING 6.5M

FLNS 001 **Spigot Nut (9mm Holes)**



FLNS001 SPIGOT NUT (9mm HOLES)

GIE - - - **Gable Infill Wedge End Cap**

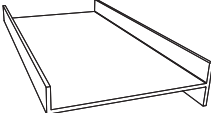

GIE001 GABLE INFILL WEDGE END CAP

GAC 001 **Gable Eaves Beam Corner**

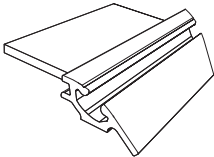

GAC001L CORNER LEFT(BOLT SLOT RETURN)
GAC001R CORNER RIGHT(BOLT SLOT RETURN)

LCP - - - **Low Pitch Lean to Eaves End Cap Block**

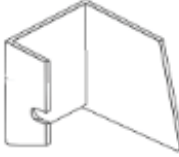

LCP001L/R LOW PITCH LEAN TO EAVES END
CAP BLOCK

LCSS - - - Compression Strut (Lantern)

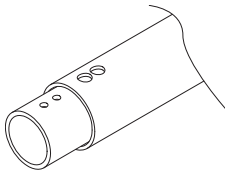

LCSS200/1 COMPRESSION STRUT 2M
LCSS200/W COMPRESSION STRUT SLEEVE 2M

LHEA - - - Lantern Header Beam

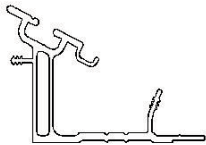

LHEA600 LANTERN HEADER BEAM
LHEA600W/1 LANTERN FASCIA
LHEA600W/2 LANTERN TOP CLOAKING

LPCD - - - Cornice Sealing Dam



LPCD001 CORNICE SEALING DAM (JOINT/ENT)
LPCD090 CORNICE SEALING DAM (MITRED JOINT)

LPCG015 Cornice Eaves Sealing Foam

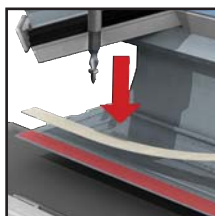

LPCG015 CORNICE EAVES SEALING FOAM

LPCP - - - Prestige Cornice

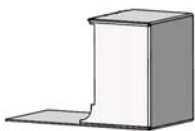

LPCP001 PRESTIGE CORNICE END PLATE
LPCP002 PRESTIGE INLINE OUTLET COVER

LPSP - - - Prestige Shelf



LPSP450/1 PRESTIGE SHELF PIERCED
LPSP450/2 PRESTIGE SHELF UN-PIERCED
LPSP001 PRESTIGE SHELF CHANNEL PIERCED

PCF - - - Glazing end profile trim

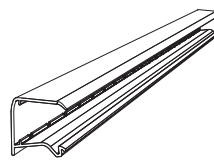

PCFC604 END PROFILE TRIM (24/25MM) 6M
PCFA635 END PROFILE TRIM (35MM) 6M

PFCA - - - V Groove fascia jointers/corners



PFCA001 JOINT INLINE
PFCA090E 90 DEG EXTERNAL
PFCA290V 90 DEG INTERNAL CORNER
PFCB135V 135 DEG INTERNAL CORNER
PFCA150 150 DEG INTERNAL CORNER

PFTB - - - V Groove fascia

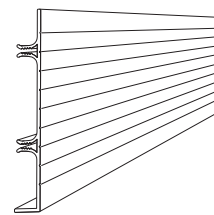

PFTB600V FASCIA CLADDING 6M

PST - - - Glazing support trim (Punched)

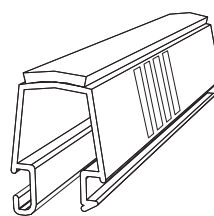

PST003 TRIM 1600MM PUNCHED
PST004 TRIM 950MM PUNCHED

(USED IN CONJUNCTIN WITH ETV001)

PSUB - - - Glazing support trim

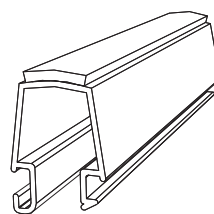

PSUB600 SUPPORT TRIM 6M

RCS 001 Drop rod bracket screw (Lantern)

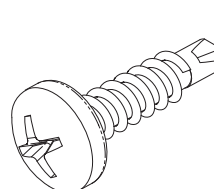

RCS001 DROP ROD BRACKET SCREW 4.2 X 13 (PAN HEAD SELF DRILL SCREW)

RES 001 **Gable eaves corner screw**

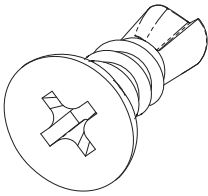

RES001 GABLE EAV CORNER SCREW 3.9 X 16
(C/SK HEAD SELD DRILL SCREW)

(ALSO USED FOR SECURING
REINFORCING IN GABLE HEAD)

RS3 510 **m6 x 20mm Bolt for Low Pitch Eaves**

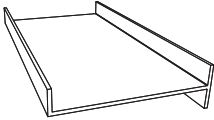

RS3510 m6 x 20mm Bolt for Low Pitch Eaves
ONLY

RVSA 002 **Compression strut/sleeve screw (Lantern)**

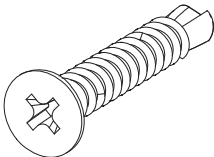

RVSA002 COMPRESSION STRUT/SLEEVE
SCREW 4.8 X 32
(C/SK HEAD SELF DRILL SCREW)

SAB 001 **Box gutter strap anchor bolt (TBRK)**

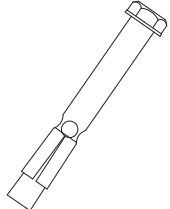

SAB001 BOX GUTTER STRAP BOLT M8 X
80MM
SAB002 BOX GUTTER STRAP BOLT M6 X
65MM

SCN - - - **Lower Cornice Section**



SCN Lower Cornice Section
(USED WITH SUPER DUTY
EAVES BEAM)

SEBA 600/1 **Structural Eaves Beam**

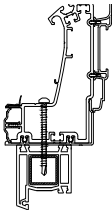

SEBA600/1 STRUCTURAL EAVES BEAM 6M

SEB 001 **Splice Plate - Structural Eaves Beam**



SEB001 SPLICE PLATE- STRUCTURAL EAVES
BEAM

SEB 002 **Eaves End Cap**



SEB002L EAVES END CAP LEFT
SEB002R EAVES END CAP RIGHT

SEB 003 **Fascia Inline Joint**



SEB003L FASCIA INLINE JOINT LEFT
SEB003R FASCIA INLINE JOINT RIGHT

(FASCIA TO BOX GUTTER)

SEB550 WW/3 **Bolster Male Cladding**

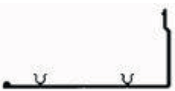

SEB550WW/3 BOLSTER MADE CLADDING

(SITS UNDER SUPER
DUTY EAVES BEAM)

SES 001 **90° butterfly strap (TBRK)**



SES001 90° BUTTERFLY STRAP

SES 002 **Inline cleat (TBRK)**

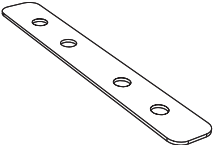

SES002 INLINE CLEAT

SES 003 Inline cleat (with transom) (TBRK)

SES003 INLINE CLEAT (WITH TRANSOM)

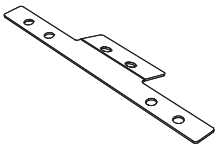

SES 004 135° butterfly strap (TBRK)

SES004 135° BUTTERFLY STRAP

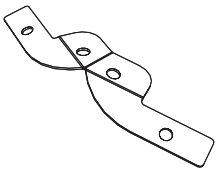

SES 005 165 Box gutter strap (TBRK)

SES005L/R 165 BOX GUTTER STRAP

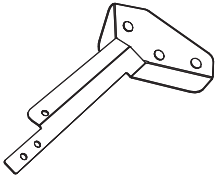

SES 006 265 Box gutter strap (TBRK)

SES006L/R 265 BOX GUTTER STRAP

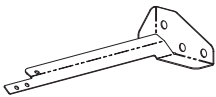

SEWC 001 Aluminium eaves moulding (TBRK)

SEWC001L/R ALUMINIUM EAVES MOULDING

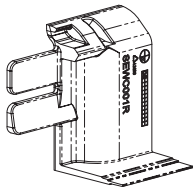

SFB - - - Decorative Ultraselect fascia

SFB600 DEC SELECT FASCIA BOARD

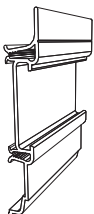

SFI - - - Decorative Ultraselect infills

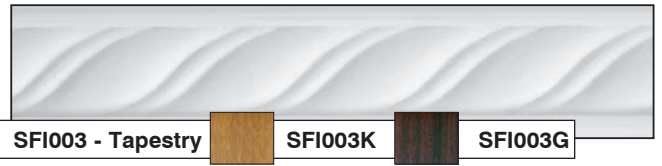

SFS 001 M6 X 16 TapTite- Splice Plate

SFS001 M6 x 16 TAPTITE- SPLICE PLATE



SGHW 001 Slotted end washer (TBRK)

SGHW001 SLOTTED END WASHER M6 X 20MM

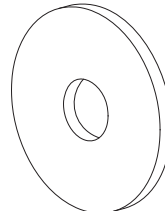

SGRK 001 Georgian ridge fixing kit (TBRK)

SGRK001 Reinforced Georgian Ridge Fixing Kit



KIT CONTENTS

- SES001 90° BUTTERFLY CLEAT (2)
- SHBB001L M6 X 30 SQUARE BOLTS (8)
- SGHW001 M6 X 20 WASHER (8)
- UZBGF001 FIXING SCREW (4)

Must be ordered with SSRK

SHBC - - - Glazing Bar Fixing Bolts

- SHBC001S SINGLE BOLT 21.5mm LONG
- SHBC001SL SINGLE BOLT 30mm LONG
- SHBC001T TWIN BOLT ASSEMBLY 21.5mm LONG
- SHBC050S SINGLE BOLT 21.5 & NUT (BAG OF 50)

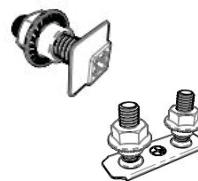

SKRA002 Roof T Spanners 10mm or 13mm

SKRA002 ROOF T SPANNERS 10MM OR 13MM
(FOR FITTING NUTS TO BOLTS)



SNP - - - **Decorative Ultraselect plain fascia infill**

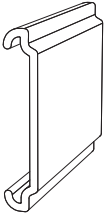

SNP600 DEC FASCIA PLAIN INFIL

TBW 002 **Washer Used with SHBC001SL**



TBW002 WASHER
(USED WITH SHBC001SL)

SSF 001 **Lantern eaves cleat screw**

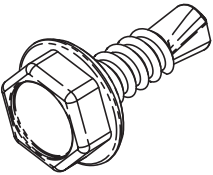

SSF001 LANTERN CLEAT SCREW 6.3 X 19

UGTB - - - **Under gutter trim**

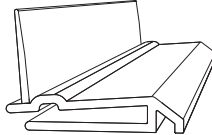

UGTB600 UNDER GUTTER TRIM 6M

SSPC 600 **Lantern beam internal cladding**

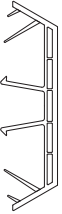

SSPC600 LANTERN BEAM INTERNAL CLADDING

UVT 004 **Starter bar reinforcing screw (TBRK)**

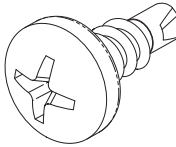

UVT004 STARTER BAR REINFORCING
SCREW
4.8 X 13 SELF TAPPING SCREW

SSRK 001 **Standard ridge fixing kit (TBRK)**



SSRK001 Reinforced Standard Ridge Fixing Kit

KIT CONTENTS

- SCFK001 WALL CLEAT FIXING KIT
- SWCP001L EAVES WALL CLEAT PAD LEFT
- SWCP001R EAVES WALL CLEAT PAD RIGHT
- SEWC001L EAVES WALL MOULDING LEFT
- SEWC001R EAVES WALL MOULDING RIGHT

UZBGF 001 **Butterfly cleat screw (TBRK)**

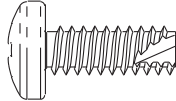

UZBGF001 BUTTERFLY CLEAT SCREW 6 X 16

(ALSO USED FOR INLINE CLEATS OR
BOX GUTTER STRAPS)

TCCA - - - **Lantern header cleat**

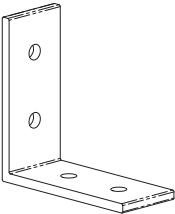

TCCA090 LANTERN HEADER CLEAT 90°
TCCA135 LANTERN HEADER CLEAT 135°

UZLPEB/ - **Low Pitch Eaves Beam**

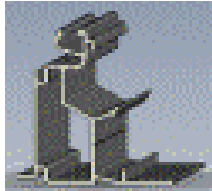

UZLPEB/1 LOW PITCH EAVES BEAM
UZLPEB/2 EAVES INNER BOTTOM TRIM
UZLPEB/3 EAVES EXTERNAL CLADDING
UZLPEB/4 INTERNAL FASCIA CLADDING

TFC 400 **Lantern header beam cladding**

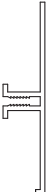

TFC400 LANTERN HEADER BEAM CLADDING

UZLPEJ001 **Sleeve to Join Inline Eaves**



UZLPE001 SLEEVE TO JOIN INLINE EAVES

UZLPFR - - -

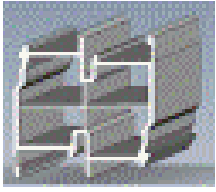

UZLPFR/1 FIRRING MAIN BODY
 UZLPFR/2 FIRRING BASE (SITS ON FRAME)
 UZLPFR/5 ALUMINIUM REINFORCEMENT
 UZLPFR/6 STEEL REINFORCEMENT

UZRI 010

Eaves moulding fixing (TBRK)



UZRI010/5 EAVES MOULDING STARTER FIXING
 M8 SINGLE COILED SPRING

(USE WITH VRK004/1)

UZSB 003

Compression strut bracket screw (Lantern)

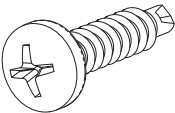

UZSB003/3 COMPRESSION STRUT BRACKET
 SCREW M6 X 12
 (C/S TAPTITE SCREW)

VAAA600H

Eaves beam

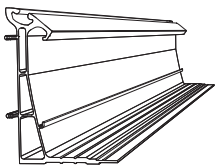

VAAA600H HEAVY MULTI EAVES BEAM 6M

VFK - - -

Victorian fixing kit

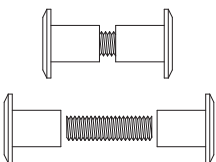

VFK001 VICTORIAN FIXING KIT
 17 x Small(22mm) & 3 x Large(37mm)
 VFK002 VICTORIAN FIXING KIT
 20 x Large(37mm)

VLPB 001/1

Eaves beam high and low pitch packer

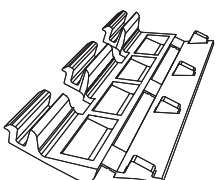

VLPB001 TRANSOM BAR PACKER (BLACK)

VPLB 002

5 way drop rod bracket (Lantern)

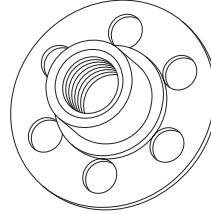

VPLB002 5 WAY DROP ROD BRACKET

VPLB 003

Compression strut fixing bracket (Lantern)

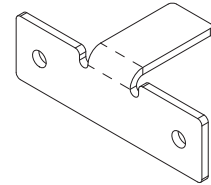

VPLB003 COMPRESSION STRUT BRACKET

VPLB 090

Lantern beam cleat 90°

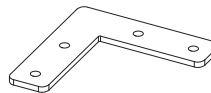

VPLB090 LANTERN BEAM CLEAT 90°

VPLB 135

Lantern beam cleat 135°

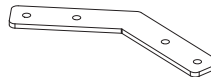

VPLB135 LANTERN BEAM CLEAT 135°

VPLB 600

Variable pitch lantern beam



VPLB600/1 VARIABLE PITCH LANTERN BEAM

VPLF 010

LANTERN RAIN BAFFLE SEALING FOAM

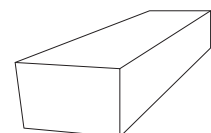

VPLF010 LANTERN RAINBAFFLE SEALING FOAM
 10M ROLL

VRK 004/1 Eaves moulding starter fixing (TBRK)

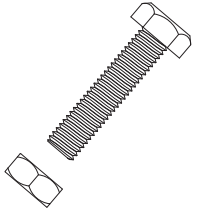

VRK004/1 EAVES MOULDING STARTER FIXING
M8 X 35 BOLT AND NUT

(USE WITH UZRI 010)

SECTION 2 - Ridge

The ridge takes the initial structural loads and is the lynch pin of the roof system

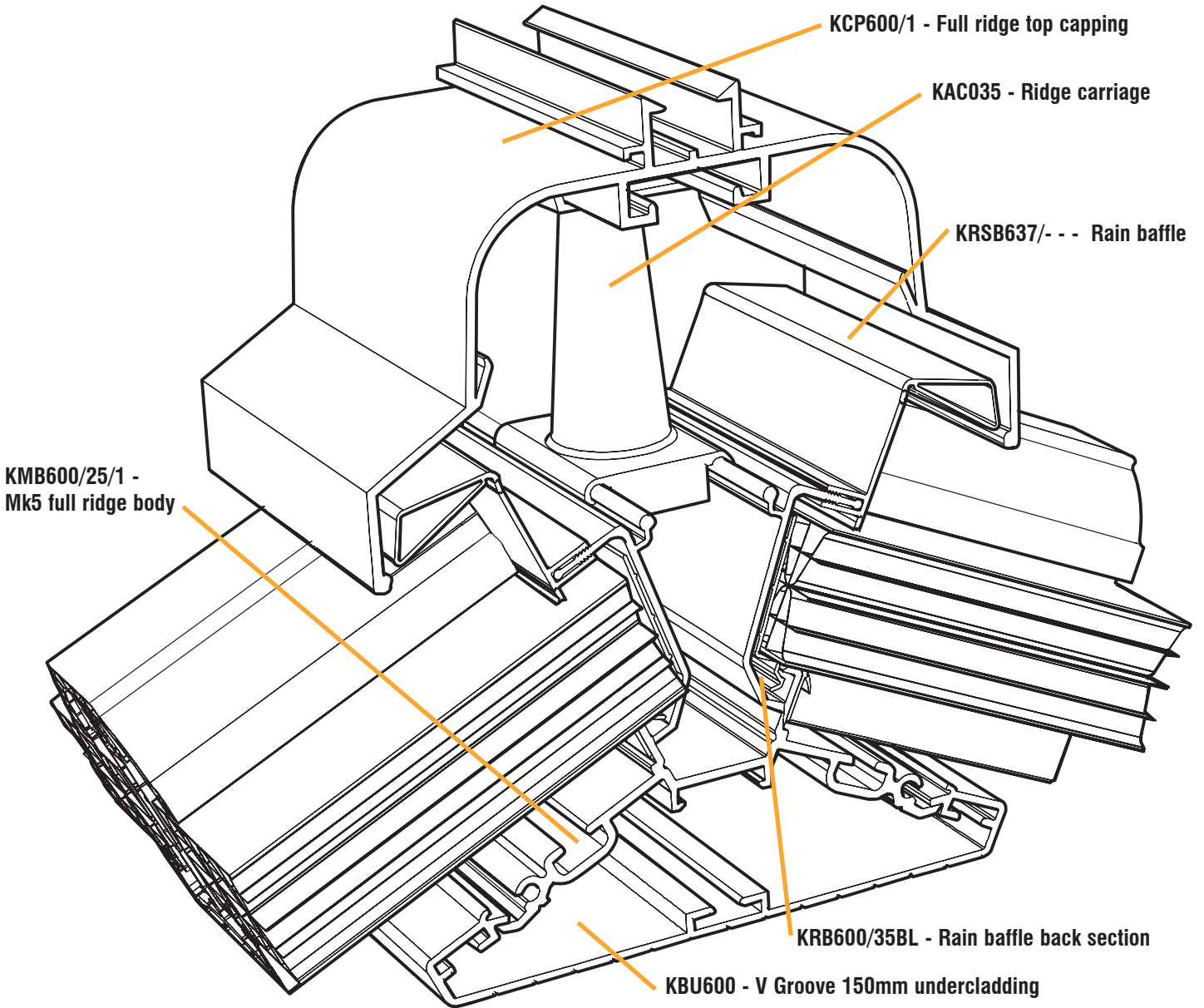

AAHA - - - Slide in bolt slot

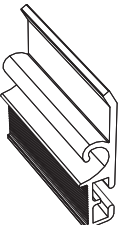

AAHA600/1 USED ON RAISED BACK BOXGUTTER

(USE SCRA ROUNDHEAD BOLTS)

BFNA 004 Sceptre finial



BFNA004 SCEPTRE MOULDED FINAL

ACC - - - Aluminium Cresting

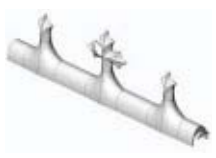

ACC001 FINIAL ADAPTOR
ACC002 FINIAL ADAPTOR FIXING
ACC050 CRESTINGS

CCE 050 Renaissance cresting

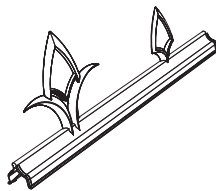

CCE050 RENAISSANCE CRESTING 500MM x 2 (EASY CLEAN, CLIP OVER)
CCE100/1 RENAISSANCE ADAPTOR (ABUTS FINIAL)

ACF 001 Ball Finial - Aluminium



ACF001 BALL FINIAL

CNL 050 Baroque cresting



CNL050 BAROQUE CREST 500MM X 2

ACP - - - Aluminium Ridge Cap



ACP---/1 RIDGE TOP CAP
ACP001 EXTERNAL RADIUS END COVER
ACP002 BRUSH- EXT RADIUS END
ACP003 RADIUS END CLAMP WASHER
ACP004 RADIUS END FLASHING TRIM

CPP 050 Elizabethan cresting



CPP050 ELIZABETHAN CREST 500MM X 2

AHC - - - Aluminium Half Ridge



AHC---/1 HALF RIDGE TOP CAP
AHC001L HALF RIDGE RADIUS END COVER-LEFT
AHC001R HALF RIDGE RADIUS END COVER-RIGHT
AHC002 BRUSH- HALF RIDGE EXT RAD END COVER

CRC 090 External (270 deg) Radius End Cover



CRC090 EXTERNAL (270 DEG) RADIUS END COVER L-SHAPE HALF RIDGE

ALP - - - Low Profile Cresting - Aluminium



ALP---/1 LOW PROFILE CRESTING

CRE 050 Classic cresting

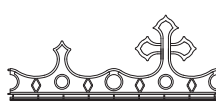

CRE050 CLASSIC CREST 500MM X 2

CRU 090 **Internal (270 deg) Radius End Cover**

CRU090 INTERNAL (270 DEG) RADIUS END COVER L-SHAPE HALF RIDGE



CSL 050 **Tudor crestring**

CSL050 TUDOR CREST 500MM X 2



CUD - - - **Low profile crestring**

CUD600 LOW PROFILE CRESTING 6M

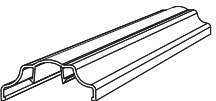

DPA - - - **Differential Pitch- Ridge Adaptor**

DPA001 DIFFERENTIAL PITCH- RIDGE ADAPTOR
DPA002 DIFFERENTIAL PITCH- RIDGE SPACER BUSH



FIN - - - **Classic finial**

FIN004 CLASSIC FINIAL
FIN001L CLASSIC FINIAL (TO SUIT WOK)



FLY - - - **Flymesh strip**

FLY620-24 FLYMESH STRIP - FULL RIDGE 24MM 6.2M

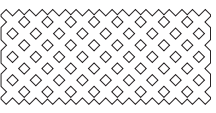

See UWC600/1 FOR HALF RIDGE FLYMESH

FUD 001 **Low profile finial**

FUD001 LOW PROFILE FINIAL

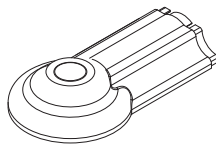

FWE 001 **Full wok external capping**

FWE001/1 FULL WOK EXTERNAL CAPPING
(VBC143 BRUSH CLIP 1430MM LG WHITE)
(VBLA143/1 RAD END BRUSH 7 SERIES 1430MM)
(ALSO NEED TWR001)

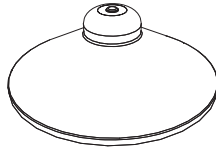

FWF - - - **Full wok foam**

FWF020-25 FULL WOK FOAM 20-25
FWF030-35 FULL WOK FOAM 30-35

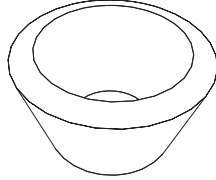

FWI 001 **Full wok internal capping**

FWI001/1 FULL WOK INTERNAL CAPPING
(ALSO NEED TWR001)

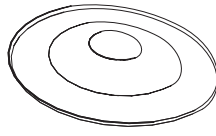

GBC - - - **Wallplate internal cladding**

GBC600 INT CLADDING 6M (PWLA)

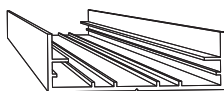

HCG - - - **Half wok external capping - georgian**

HCG003 15-20° GEORGIAN HALF WOK CAP INC CLIPS
HCG004 25-30° GEORGIAN HALF WOK CAP INC CLIPS
VBLA080/1 RAD END BRUSH 7 SERIES BAR 800MM GEORGIAN

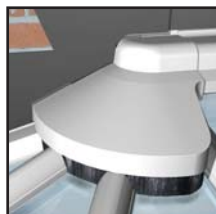

HCV - - - Half wok external capping - victorian

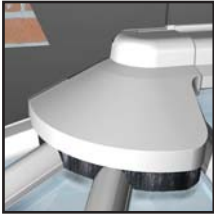

- HCV003 15-20° VICTORIAN HALF WOK CAP INC CLIPS
- HCV004 25-30° VICTORIAN HALF WOK CAP INC CLIPS
- VBLA069/1 RAD END BRUSH 7 SERIES BAR 690MM VICTORIAN

KBEA 001 Radius end undercladding ext. bracket

- KBEA001 UNDERCLADDING EXTENSION BRKT

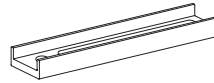

KBF 001 Radius end undercladding bracket

- KBF001 UNDERCLADDING BRACKET

(INC IN KFKA001 KIT)



HRP - - - Half wok internal capping - georgian



- HRP001 HALF RIDGE ADAPTOR SMALL
- HRP002 HALF RIDGE ADAPTOR MAIN PLATE

KBS 001 Cross brace fixing screw

- KBS001 CROSS BRACE SCREW 10 X 3/8 (4.8 X 9.5 SELF DRILLING SCREW)

(ALSO USED TO SECURE STRUCTURAL TOP CARRIAGE - FULL OR HALF RIDGE)

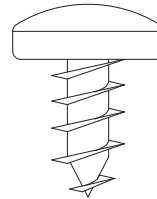

HWF - - - Half wok foam

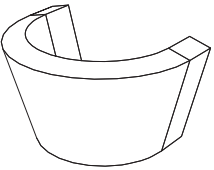

- HWF005-15 HALF WOK FOAM
- HWF020-25 HALF WOK FOAM 20-25
- HWF030-35 HALF WOK FOAM 30-35

KBU - - - V groove 150mm undercladding

- KBU600 UNDERCLADDING 5.97MM WHI

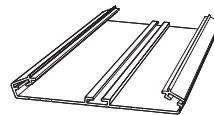

KAC 035 Ridge carriage

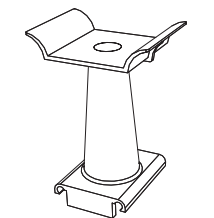

- KAC035 RIDGE CARRIAGE

(IN CONJUNCTION WITH KTBA)

KCG - - - Georgian separate end capping external

- KCG003 15-20DEG GEORG END CAPPING INC CLIPS
- KCG004 25-30DEG GEORG END CAPPING INC CLIPS

(ALSO NEED)

- VBLA080/1 RAD END BRUSH 7 SERIES BAR 800MM GEORGIAN
- SCRA004 STARLOC WASHER

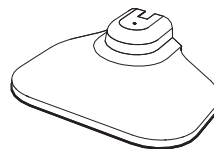

KBC 075 Ridge cross brace

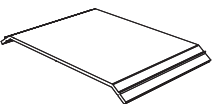

- KBC075 CROSS BRACE 20 DEG 75MM
- KBC075-15 CROSS BRACE 15 DEG 75MM

KCP - - - External ridge capping

- KCP600/1 EXT RIDGE CAPPING SECTION 5.98M

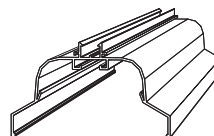

KBC 300 Ridge joint plate



- KBC300 JOINT PLATE 300MM 20-35 DEG
- KBC300-15 JOINT PLATE 300MM 15 DEG

KCS - - - **Ridge top carriage**

KCS060 RIDGE TOP CARRIAGE 60MM (10)
 KCS300 RIDGE TOP CARRIAGE 300MM



KCT 001/1 **Ridge top cap inline jointer**

KCT001/1 RIDGE TOP CAP INLINE JOINTER

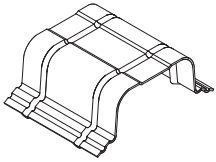

(RIVETS VSR001 & TAPE BST500A NOT INCLUDED)
 *TRIMMED TO SUIT HALF RIDGE INLINE JOINTING

KCV - - - **Victorian separate end capping external**

KCV003 15-20 DEG VICTORIAN END CAP INC CLIPS
 KCV004 25-30 DEG VICTORIAN END CAP INC CLIPS

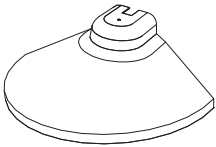

(ALSO NEED)
 VBLA069/1 RAD END BRUSH 7 SERIES BAR
 690MM VICTORIAN
 SCRA004 STARLOC WASHER

KDE 001 **Die cast end**

KDE001 RIDGE DIE CAST END

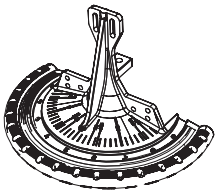

KDH 001 **Half ridge die cast end**

KDH001L HALF RIDGE DIE CAST END (LEFT)
 KDH001R HALF RIDGE DIE CAST END (RIGHT)

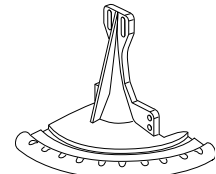

KDS 001 **Die cast end/Ridge bolster fixing screws**

KDS001 FULL RIDGE DIE CAST END & TBRK
 RIDGE BOLSTER FIXING SCREWS
 (4.8 X 25 SELF TAPPING SCREW)



KDS 002 **Half ridge die cast end upper screw**

KDS002 HALF RIDGE DIE CAST END UPPER
 SCREW
 (4.8 X 38 SELF TAPPING SCREW)

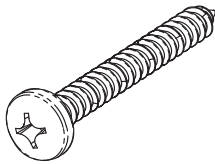

KDS 003 **Half ridge adaptor plate lower screws**

KDS003 HALF RIDGE ADAPTOR PLATE LOWER
 SCREWS
 (5 X 37 C/SINK WOOD SCREW)

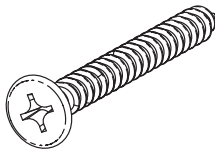

KFD 001 **Georgian Cap Finial Disk**

KFD001 GEORGIAN CAP FINIAL DISK



KFEC - - - **Slotted end (small) - full ridge**

KFEC015 SLOTTED END 15° SMALL RAD
 KFEC020 SLOTTED END 20° SMALL RAD
 KFEC025 SLOTTED END 25° SMALL RAD
 KFEC030 SLOTTED END 30° SMALL RAD
 KFEC035 SLOTTED END 35° SMALL RAD
 KFEC040 SLOTTED END 40° SMALL RAD



KFKA 001 **Internal radius end fixing kit**

KFKA001/1 RADIUS END FIXING KIT WHITE



KIT CONTENTS
 KBF001 RAD END UNDERCLADDING BRACKET
 KLB001 ROSELOCK FIXING BUTTON
 SCRA001 ROOFING BOLT AND NUT

KFSB 001 **Ridge end foam bung**

KFSB001 RIDGE END FOAM

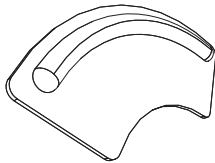

KFSC - - - Slotted end (large) - full ridge

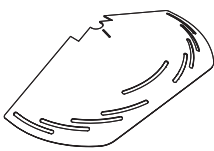

KFSC015	SLOTTED END 15° LARGE RAD
KFSC020	SLOTTED END 20° LARGE RAD
KFSC025	SLOTTED END 25° LARGE RAD
KFSC030	SLOTTED END 30° LARGE RAD
KFSC035	SLOTTED END 35° LARGE RAD
KFSC040	SLOTTED END 40° LARGE RAD

KHC - - - Half ridge top capping

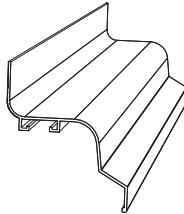

KHC600	HALF RIDGE TOP CAPPING 6M
--------	---------------------------

KFT 001 Ridge flashing trim

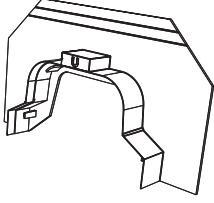

KFT001	RIDGE FLASHING TRIM
--------	---------------------

KHF 001 Ridge/half ridge capping jointer

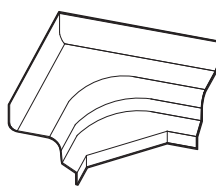

KHF001	RIDGE/HALF RIDGE CAPPING JOINTER (TOP OF VALLEY)
--------	--

KGEA 001 Gable end complete

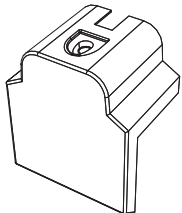

KGEA001	GABLE END CAP COMPLETE (INCLUDES KFD001 FINIAL DISC)
---------	--

KHG - - - Georgian half ridge radius end cap

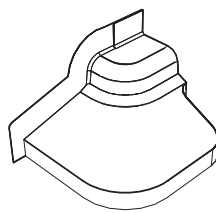

KHG015L-21	15DEG GEORGIAN 21TRIM LEFT
KHG015R-21	15DEG GEORGIAN 21TRIM RHT
KHG025L-21	25DEG GEORGIAN 21TRIM LEFT
KHG025R-21	25DEG GEORGIAN 21TRIM RHT
(ALSO NEED)	
VBC044	BRUSH CLIP 440MM
VBLA044/1	RAND END BRUSH 440MM

KGR - - - Georgian internal separate end cover

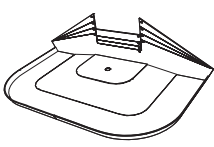

KGR001	GEORGIAN SEP END COVER SMALL
KGR002	GEORGIAN SEP END COVER LARGE
KGR002UT	GEORGIAN SEP END COVER LARGE UNTRIM

KHI - - - Victorian half ridge & wok under capping

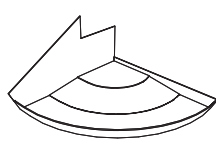

KHI001L	HR UNDER CAP SM RADIUS LEFT
KHI001R	HR UNDER CAP SM RADIUS RIGHT
KHI002L	HR UNDER CAP LRG RADIUS LEFT
KHI002R	HR UNDER CAP LRG RADIUS RIGHT

KHA 001 Half ridge rad end fixing plate

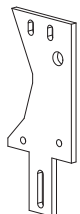

KHA001L	HR RAD END FIXING PLATE LEFT
KHA001R	HR RAD END FIXING PLATE RIGHT
	(USED WITH DIE CAST END ONLY)

KHI - - - Georgian half ridge & wok under capping

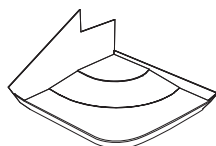

KHI003L	HR UNDER CAP SM RADIUS LEFT
KHI003R	HR UNDER CAP SM RADIUS RIGHT
KHI004L	HR UNDER CAP LRG RADIUS LEFT
KHI004R	HR UNDER CAP LRG RADIUS RIGHT

KHB - - - Half ridge/Lantern baffle support wing

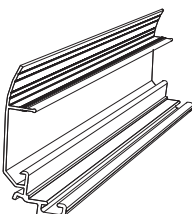

KHB600/35	HALF RIDGE ALUM BAFFLE SUPPORT WING 6M
-----------	--

KHL 001 Half ridge end cap (left)

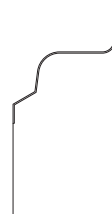

KHL001	HALF RIDGE END CAP (LEFT)
	(KHR FOR RIGHT HAND)

KHM - - -

Mk5 half ridge main body

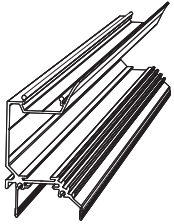

KHM600 HALF RIDGE MAIN BODY 6M

KLB 001

Rose locking fixing button

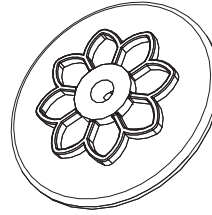

KLB001 ROSE LOCKING FIXING BUTTON
(INC IN KFKA001 KIT)

KHR 001

Half ridge end cap (Right)

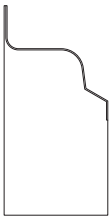

KHR001 HALF RIDGE END CAP (RIGHT)
(KHL FOR LEFT HAND)

KMBA - - - Mk5 full ridge main body (punched & meshed)

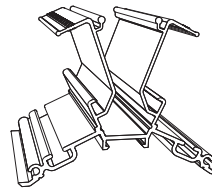

KMBA600/35/15/1 MK5 FULL RIDGE BODY - 15°
KMBA600/35/20/1 MK5 FULL RIDGE BODY - 20°
KMBA600/35/25/1 MK5 FULL RIDGE BODY - 25°
KMBA600/35/30/1 MK5 FULL RIDGE BODY - 30°
KMBA600/35/35/1 MK5 FULL RIDGE BODY - 35°
KMBA600/35/40/1 MK5 FULL RIDGE BODY - 40°

KHS 060

Half ridge structural carriage

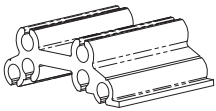

KHS060 HALF RIDGE STRUCTURAL CARRIAGE

KOB 002

Ventilation button

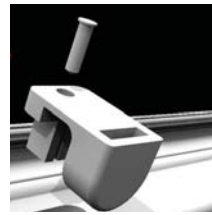

KOB002 VENTILATION OPERATION BUTTON
(MAIN RIDGE UNDERCLADDING)

KHU - - -

Half ridge/Lantern under cladding

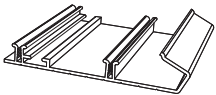

KHU600 UNDERCLADDING 6M WH

KRAA - - -

Bolt-on ridge plate - slotted end

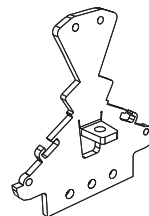

KRAA001L BACK PLATE 15°-30°
KRAA001R BACK PLATE 15°-30°
KRAA015/2 15° bolt-on ridge plate - slotted end
KRAA020/2 20° bolt-on ridge plate - slotted end
KRAA025/2 25° bolt-on ridge plate - slotted end
KRAA030/2 30° bolt-on ridge plate - slotted end
KRAA035/2 35° bolt-on ridge plate - slotted end
KRAA040/2 40° bolt-on ridge plate - slotted end

KHV - - -

Victorian half ridge radius end cap

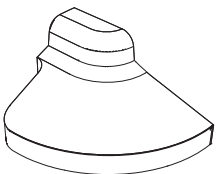

KHV015L-21 15DEG VICTORIAN 21TRIM LFT
KHV015R-21 15DEG VICTORIAN 21TRIM RHT
KHV025L-21 25DEG VICTORIAN 21TRIM LFT
KHV025R-21 25DEG VICTORIAN 21TRIM RHT

(ALSO NEED)
VBC380 BRUSH CLIP 380MM VBLA038/1 RAD
END BRUSH 380MM

KRB - - -

Rain baffle back section

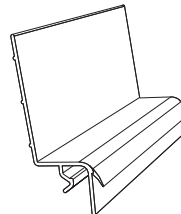

KRB600/35BL RAIN BAFFLE BACK SECTION
35MM BLACK 6M

KJB - - -

Ridge joint bracket kit (300mm)

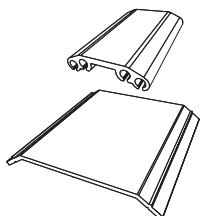

KJB001 JOINT BRACKET KIT 15 DEG
KJB002 JOINT BRACKET KIT 20-35D

(INCLUDES 24 X RCS001 FIXING SCREWS)

KRSB - - -

Rain baffle

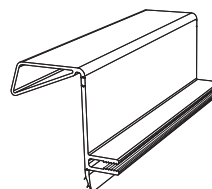

KRSB637/16L 7 SE'S 25MM LOW PITCH 6.3m
KRSB637/16S 7 SE'S 25MM STEEP PITCH 6.3m
KRSB637/32L 7 SE'S 35MM LOW PITCH 6.3m
KRSB637/32S 7 SE'S 35MM STEEP PITCH 6.3m

KTBA 001

Ridge T bolt and fixing wedge

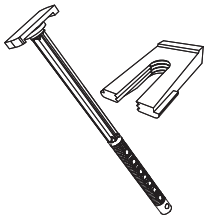

KTBA001/1 RIDGE T BOLT
KTBA001/2 FIXING WEDGE

(IN CONJUNCTION WITH KAC 035)

KVRA - - -

Radius end undercladding

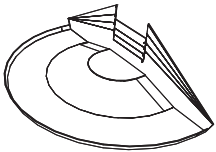

KVRA001 SMALL RADIUS END UNDERCLADDING
KVRA002 LARGE RADIUS END UNDERCLADDING
KVRA002UT LARGE RADIUS END UNDERCLAD UNTRIMMED

PSF 004

Pikestaff finial



PSF004 PIKESTAFF FINIAL

PWLA - - -

Lean-to wallplate body

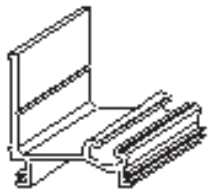

PWLA600/1 LEAN TO WALL PLATE BODY
5-45 DEG WALL PLATE 6M

(NO TOP CAPPING SUPPLIED)

- - -

Quarter wok external capping - georgian

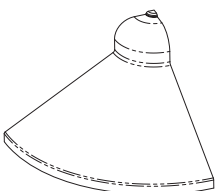

(KHG MODIFIED) HALF RIDGE CAPPING

VBL 044 BRUSH AND CLIP 440MM

- - -

Quarter wok external capping - victorian

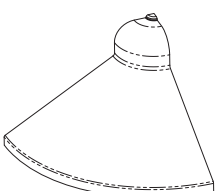

(KHV) HALF RIDGE CAPPING MODIFIED)

VBC380 BRUSH CLIP 380MM
VBLA380/1 RAD END BRUSH 380MM

- - -

Quarter wok internal capping - georgian

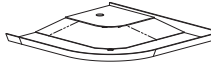

KHI003LorR MODIFIED GEORGIAN COV SM
KHI004LorR MODIFIED GEORGIAN COV LRG

(ALSO NEED TWR001)

- - -

Quarter wok internal capping - victorian

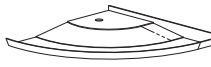

KHI001LorR MODIFIED VICTORIAN COV SM
KHI002LorR MODIFIED VICTORIAN COV LRG

(ALSO NEED TWR001)

RAP - - -

Ridge Adaptor



RAP001 CAST RIDGE ADAPTOR 25-30 DEG
RAP002 CAST RIDGE ADAPTOR 15-20, 35 DEG
RAP003 CAST RIDGE ADAPTOR 40 DEG

RCS - - -

Ridge structural carriage screws

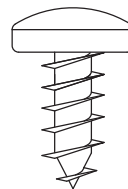

RCS001 RIDGE CARRIAGE SCREWS
4.2 X 13MM
RCS002 HALF RIDGE WING TO MAIN BODY
4.2 X 10MM

RHK 001

Ridge hanger kit (TBRK)

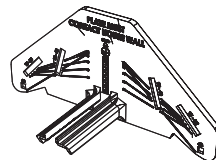

RHK001 RIDGE HANGER KIT

KIT CONTENTS

SRCP001 COMPRESSION PLATE (1)
SSBR030 STARTER REINFORCEMENT (2)
RHSH001 HANGER SUB KIT
SRE003 TBRK LABEL
CIL178 CONTENTS LIST

SARC - - -

Ridge bolster (TBRK)

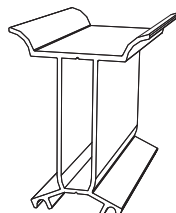

SARC600 RIDGE BOLSTER

SFNA 004

Coronet finial



SFNA004 CORONET FINIAL

SSA 001

Speedlok 2 Socket Assembly



SSA001 SPEEDLOCK 2 SOCKET ASSEMBLY

SHI - - -

Internal Radius End Covers

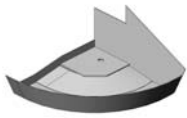

SHI001L Vic Small Int Rad End Cover H/R
 SHI001R Vic Small Int Rad End Cover H/R
 SHI002L Vic Large Int Rad End Cover H/R
 SHI002R Vic Large Int Rad End Cover H/R
 SHI003L Geor Small Int Rad End Cover H/R
 SHI003R Geor Small Int Rad End Cover H/R
 SHI004L Geor Large Int Rad End Cover H/R
 SHI004R Geor Large Int Rad End Cover H/R
 SHI010/1 Rose Fixing Plate Assembly
 SHI010/2 Nylon Washer Nut

SSC 001

Speedlok Housing Spacer



SSC001 SPEEDLOCK HOUSING SPACER

SSL 001

Short Speedlock 2 Assembly



SSL001 SHORT SPEEDLOCK 2 ASSEMBLY

SLH - - -

New Die Cast Ridge End Full Ridge



SLH002 HUB WEATHERING SHIELD
 SLH004 SPEEDLOK HUB 1/4 ADAPTOR
 SLH005 TIE BAR/ BRACKET FOR INT RAD FIX
 SLH006 FULL WOK WEATHERING SHIELD
 SLH007 QUARTER WOK WEATHERING SHIELD
 SLH008 3/4 'L' WEATHERING SHIELD
 SLH009 FULL WOK DIE CAST END
 SLH010 3/4 WOK DIE CAST END
 SLH011 1/2 WOK DIE CAST END
 SLH012 1/4 WOK DIE CAST END
 SLH013 3/4 WOK WEATHERING SHIELD
 SLH014 1/2 WOK WEATHERING SHIELD
 SLH015 1/2 RIDGE L SHAPE HUB SUPPORT BRACKET

TFR 200

Threaded Fixing Rose



TFR200 THREADED FIXING ROSE
 (INT RAD END TO LOW PRO CREST)

TWR 001

Wok threaded fixing rose



TWR001 WOK THREADED FIXING ROSE 100MM
 TWR001L WOK THREADED FIXING ROSE 150MM

SLHA - - -

New Die Cast End - Half Ridge



SLHA001 SPEEDLOK HUB
 SLHA001L SPEEDLOK HALF RIDGE HUB
 SLHA001R SPEEDLOK HALF RIDGE HUB
 SLHA003 SPEEDLOK EXT CORNER DIE CAST

(THE ABOVE USED FOR HALF RIDGES- CUT TO SUIT)

UOB 001

Opening button



UOB001 OPENING BUTTON ON UNDERCLADDING
 (HALF RIDGE OR VENTILATED WALLPLATE)

UWC - - - Half ridge flymesh

UWC600/1 FLYMESH STRIP (18MM)
- HALF RIDGE

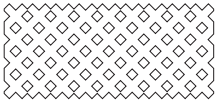

WTC - - - Ventilated wallplate top capping

WTC600/1 WALLPLATE TOP CAPPING

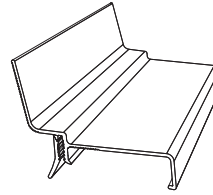

VSR 001 Plastic snap rivet - ridge cap

VSR001 PLASTIC SNAP RIVETS-RIDGE CAP

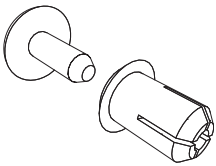

WUC - - - Ventilated wallplate undercladding

WUC600 INCLUDING MESH OR BUTTON
WUC600/1 WALLPLATE UNDERCLADDING
INCLUDING VENT STRIP

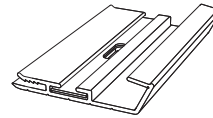

WCP 001 Ventilated wallplate 5degree packer

WCP001/1 WALLPLATE 5° PACKER
(PITCHES FROM 15 TO 30 DEGS)

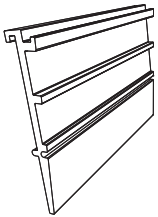

WCS - - - Ventilated wallplate carriage

WCS100/35 WALLPLATE CARRIAGE 100MM

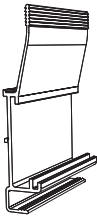

WEC 001 Ventilated wallplate end cap

WEC001/L WALLPLATE END CAP (LEFT)
WEC001/R WALLPLATE END CAP (RIGHT)

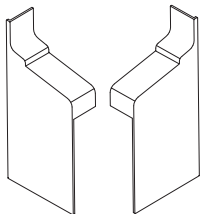

WMB - - - Ventilated wallplate main body

WMB600/35/1 WALLPLATE MAIN BODY (5-10°)
WMB600/35/2 WALLPLATE MAIN BODY (10-15°)

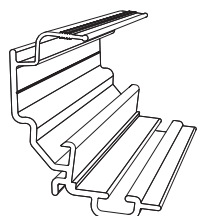

SECTION 3 - Glazing bars

Glazing bars are the members that retain the glazing material and take structural loads down to the eaves

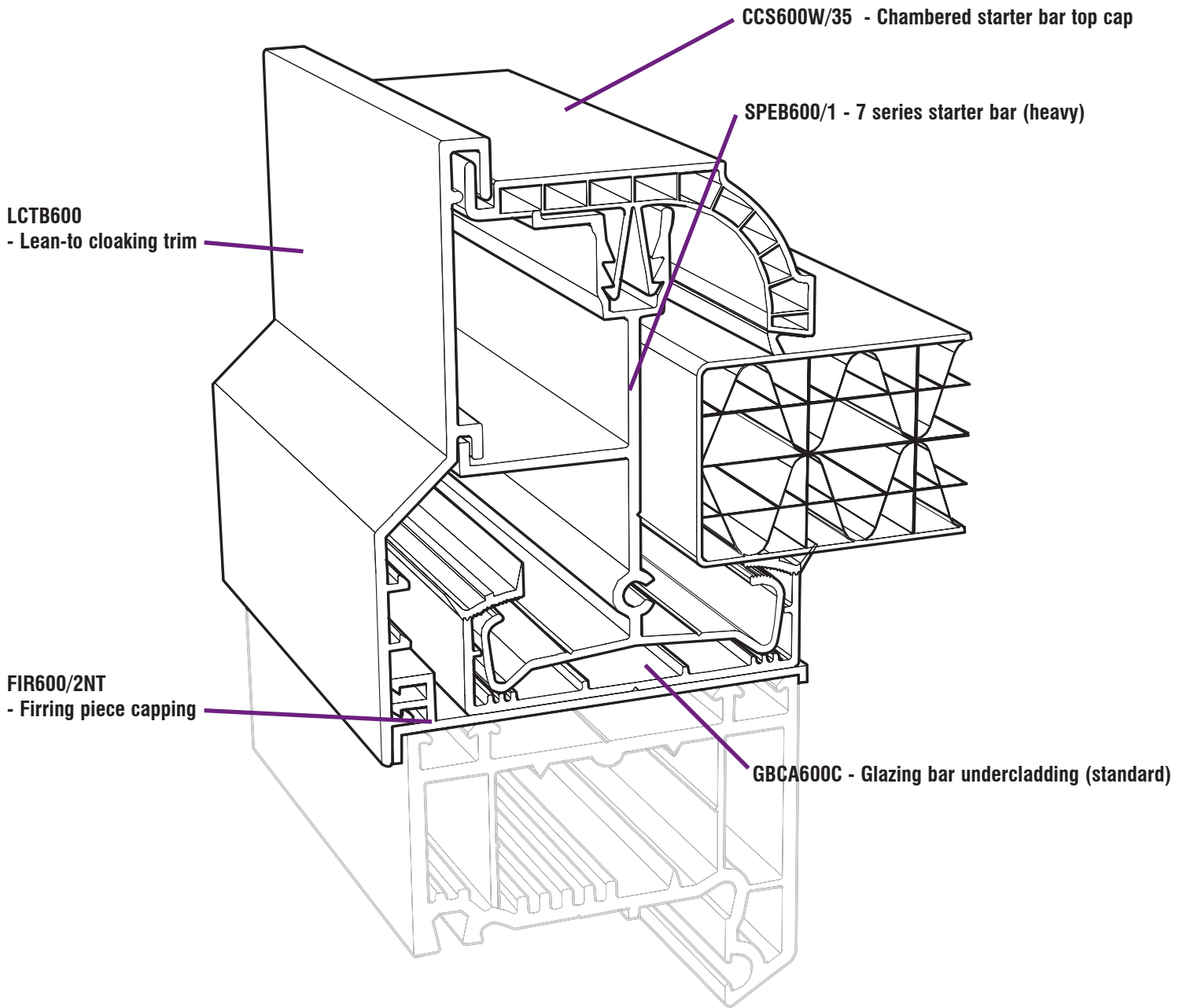

SECTION 3 - Glazing bars

AGC- - - Georgian Top Cap - Aluminium

AGC---/25 GEORGIAN END CAP

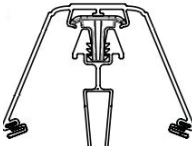

AGS- - - Qlon Gasket

AGS250 QLON GASKET

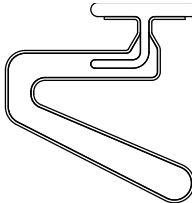

ALC- - - Lean to Cloaking Trim - Aluminium

ALC---/1 LEAN TO CLOAKING TRIM



AOC- - - Transom Top Cap - Aluminium

AOC---/25 TRANSOM TOP BAR



ASC- - - Starter Bar Top Cap - Aluminium

ASC---/25 STARTER BAR TOP CAP



ATC- - - Transom Top Cap - Aluminium

ATC---/25 TRANSOM TOP BAR



BEC 001 Bolster Bar End Cap

BEC001 BOLSTER BAR END CAP

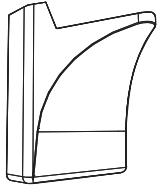

BFK 020 Bolster Bar Fixing Kit

BFK020 BOLSTER BAR FIXING KIT PACK INCLUDING SELF SEALING WASHER (6.3 X 25)
(PACK OF 20)

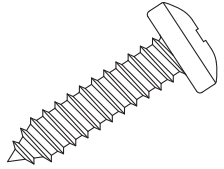

BFS 001 Bolster Fixing Screw

BFS001 BOLSTER BAR FIXING SCREW

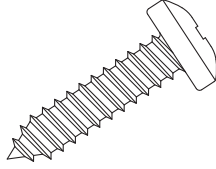

CAPA - - - Glazing Bar Top Cap

CAPA6011 GLAZING BAR TOP CAP STARTER
CAPA604 GLAZING BAR TOP CAP VIC/TRANSOM
CAPA606 GLAZING BAR TOP CAP GEORGIAN
(24/25MM GLAZING ONLY)

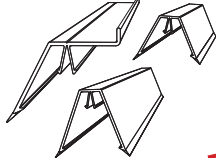

REMEDIALS ONLY

CCA - - - Chambered Glazing Bar Top Cap (Dome)

CCA600W/25 TRANSOM CAPPING 25MM
CCA600W/35 TRANSOM CAPPING 35MM

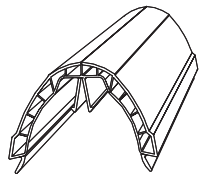

CCE 001 Chambered Starter Bar End Cap

CCE001LW - CHAMBERED STARTER BAR END CAP (LEFT)
CCE001RW - CHAMBERED STARTER BAR END CAP (RIGHT)

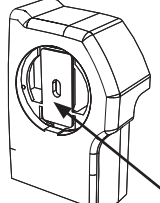

'Snap out' bar end cap fixing blocks

CCE 002 Chambered End Cap (Gable/Lean-to)

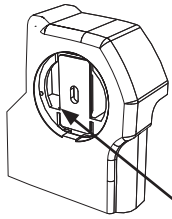

CCE002LW - CHAMBERED END CAP GABLE/LEANTO (LEFT)

CCE002RW - CHAMBERED END CAP GABLE/LEANTO (RIGHT)

'Snap out' bar end cap fixing blocks

DBC - - - Decorative Glazing Bar Cladding (Round)

DBC600 ROUND EDGE GLZ BAR U/CLAD 6M

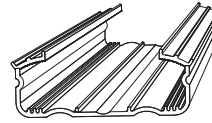

CCG - - - Chambered Georgian Glazing Bar Top Cap

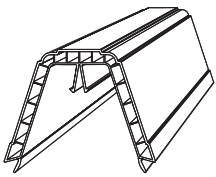

CCG600W/25 GEORGIAN CAPPING 25MM

CCG600W/35 GEORGIAN CAPPING 35MM

*USE WITH DOME OR BEVEL DESIGN

DCM 001 Decorative End cap rose motif

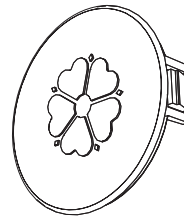

DCM001 DECORATIVE END CAP ROSE MOTIF

(ONE NEEDED WITH EACH END CAP)

CCG 001 Chambered Georgian Glazing Bar End Cap

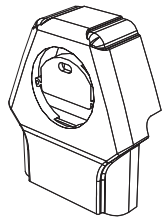

CCG001W CHAMBERED GEORGIAN END CAP

DGCE 010 Glass Clip Pack



DGCE010 GLASS CLIP PACK (5 LEFT, 5 RIGHT)

CCS - - - Chambered Starter Bar Top Cap

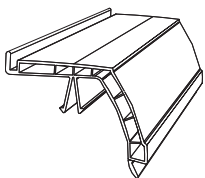

CCS600W/25 - CHAMBERED STARTER BAR TOP CAP 25
CCS600W/35 - CHAMBERED STARTER BAR TOP CAP 35

*USE WITH DOME OR BEVEL DESIGN.

DHC - - - Decorative Glazing Bar Cladding (Square)

DHC600 SQUARE EDGED HIP BAR U/CLAD 6M

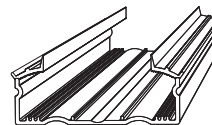

(ALWAYS USED ON GEORGIAN HIP BAR WITH JACK RAFTER)

CCT - - - Chambered Glazing Bar Top Cap (Bevel)

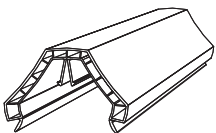

CCT600W/25 TRANSOM CAPPING 25MM

CCT600W/35 TRANSOM CAPPING 35MM

DPCA 010 Polycarbonate Clip Kit



DPCS010 POLYCARBONATE CLIP KIT

(5 LEFT, 5 RIGHT)

CCT 001 Chambered Glazing Bar End Cap (Dome)

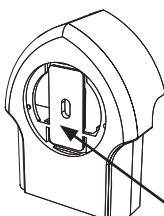

CCT001W DOME CHAMBERED TRANSOM END CAP

ALSO USED WITH BEVEL

'Snap out' bar end cap fixing blocks

EFSA 021 Endcap Fixing Screw

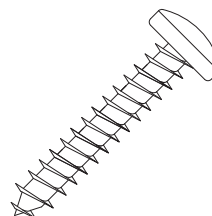

EFSA021 STANDARD (20 PACK)
(4.8 X 25 SELF TAPPING SCREW)

SECTION 3 - Glazing bars

FIR - - -

Firring Piece Capping (Use with LTCB---)

FIR600/2NT FIRRING PIECE CAPPING 6M NO TAPE

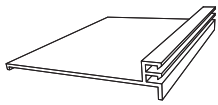

(SEE ALSO LTCB)

KSSA 002

Speedlok Kit (Standard)

KSSA002 SPEEDLOK KIT FOR 7 SERIES G/BAR

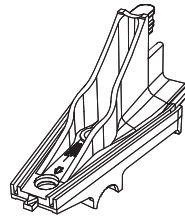

GBCB - - -

Glazing Bar Undercladding (Standard)

GBCB600C GLAZING BAR CLADDING 6M WHITE

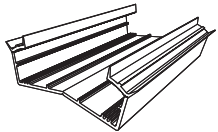

LCTB - - -

Lean-to Cloaking Trim

LCTB600 LEAN-TO CLOAK TRIM 6M

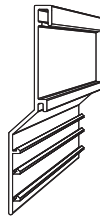

(SEE ALSO FIR)

GCRA 002

Glazing Bar Top Cap Removal Tool



GCRA002 GLAZING BAR TOP CAP REMOVAL TOOL

LSL 001

Long Speedlock 2 Assembly

LSL001 LONG SPEEDLOCK 2 ASSEMBLY



IRK - - -

Inter Rafter Kit



IRK001 INTER RAFTER TENNON
 IRK002 STRUCTURAL JACK RAFTER BASE KIT
 IRK003 INTER RAFTER WEATHERING SHIELD
 IRK004 EXTENDED INTER RAFTER KIT
 IRK005 FLASHING TRIM- RUNBER

LVCC 001

Aluminum Top Capping Fixing Cap

LVCC001 ALUMINIUM TOP CAPPING FIXING CLIP

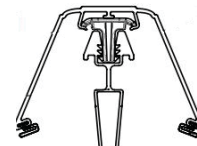

(SHOW CLIP ONLY)

JRKA - - -

Jack Rafter Kit

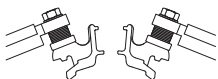

JRKA001/2 JACK RAFTER CHANNEL INFIL 15MM
 JRKA002 JACK RAFTER KIT(7)
 JRKA003 JACK RAFTER KIT 7+ REINF BAR
 JRKA004/1 M4 X 12 PZ PAN
 JRKA004/3 M6 FM B PLAIN WASHER

LWH 001

Long Speedlok 2 Weathering Hood

LWH001 LONG SPEEDLOK 2 WEATHERING HOOD



KSLD 001

Speedlok Kit (Large)

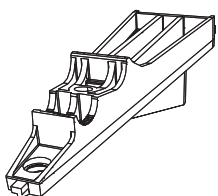

KSLD001 SPEEDLOK FOR 7 SERIES BARS

MBBA - - -

Bolster Bar - Aluminium

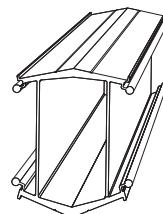

MBBA550/1 ALUMINIUM BOLSTER BAR

MBB - - - Bolster Bar - PVC Claddings

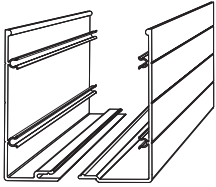

MBB550/2 BOLSTER PVC CLADDING (FEMALE)
 MBB550/3 BOLSTER PVC CLADDING (MALE)

SPE - - - 7 Series Starter Bar (Light)

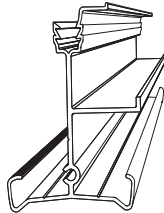

SPE600L/1 LIGHT STARTER BAR 6M

RECA 001 Glazing Bar End Cap - Transom/ Hip



RECA001 GLAZING BAR END CAP (MOTIF)

REMEDIALS ONLY

FIXING PLATE (ALREADY ATTACHED)



SPE - - - 7 Series Starter Bar (Medium)

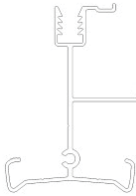

SPE600M/1 STARTER GLAZING BAR (78) 6M

RECA - - - Glazing Bar End Cap - Starter



RECA001L STARTER END CAP (MOTIF) LEFT
 RECA001R STARTER END CAP (MOTIF) RIGHT

REMEDIALS ONLY

FIXING PLATE (ALREADY ATTACHED)



SPGA - - - 7 Series Georgian Bar (Light)



SPGA600L/1 LIGHT GEORGIAN HIP BAR 6M

RECB 002 Glazing Bar End Cap (lean-to and gable application)



RECB002L LEAN-TO & GABLE END CAP (MOTIF) LEFT
 RECB002R LEAN-TO & GABLE END CAP (MOTIF) RIGHT

REMEDIALS ONLY

FIXING PLATE (ALREADY ATTACHED)



SPGC - - - 7 Series Georgian Bar (Heavy)

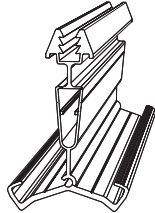

SPGC600/1 GEORG HIP GLAZING BAR (78MM) 6M

SBB 001 Starter Bar Fixing Bracket



SBB001 STARTER BAR FIXING BRACKET

SPT 600L/1 7 Series Transom/Vic Bar (Light)

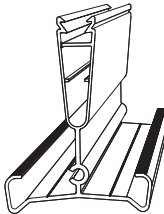

SPT600L/1 LIGHT TRANS/VIC GLAZING BAR 6M

SFS 001 Speedlok 2 Fixing Screw



SFS001 SPEEDLOK 2 FIXING SCREW

SPT 600M/1 7 Series Transom/Vic Bar (Medium)

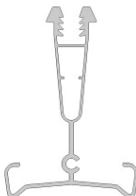

SPT600M/1 MEDIUM TRANS/VIC GLAZING BAR 6M

SPTA - - - 7 Series Transom/Vic Bar (Heavy)

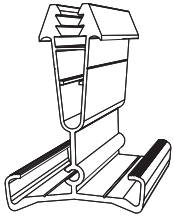

SPTA600/1 TRANSOM GLAZING BAR (78MM) 6M

SWH - - - Weathering Hood Short



SWH001 WEATHERING HOOD SHORT

SRGB - - - Georgian Structural Reinforcement

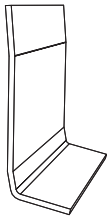

SRGB600 GEORGIAN STRUCTURAL REINFORCEMENT 6M

PLEASE USE TWO PIECES PER BAR
USE JRKA004/1 (SCREW) TO SECURE

TCAC - - - Anchor Clips

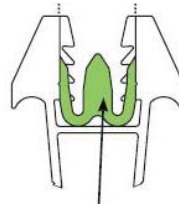

TCAC500 ANCHOR CLIPS (PACK OF 500)

SRTB - - - Transom Structural Reinforcement

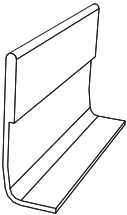

SRTB600 TRANSOM STRUCTURAL REINFORCEMENT 6M

PLEASE USE TWO PIECES PER BAR
USE JRKA004/1 (SCREW) TO SECURE

TCAD - - - Router Bit for Anchor Clips



TCAD001 ROUTER BIT FOR ANCHOR CLIPS

SSA - - - Speedlok 2 Socket Assembly



SSA001 SPEEDLOK 2 SOCKET ASSEMBLY

SSC - - - Speedlok Housing Spacer



SSC001 SPEEDLOK HOUSING SPACER

SSL - - - Short Speedlok 2 Assembly



SSL001 SHORT SPEEDLOK 2 ASSEMBLY

SECTION 4 - Valley

Another structural member that links the ridge to the eaves. It enables more complex roof shapes to be designed

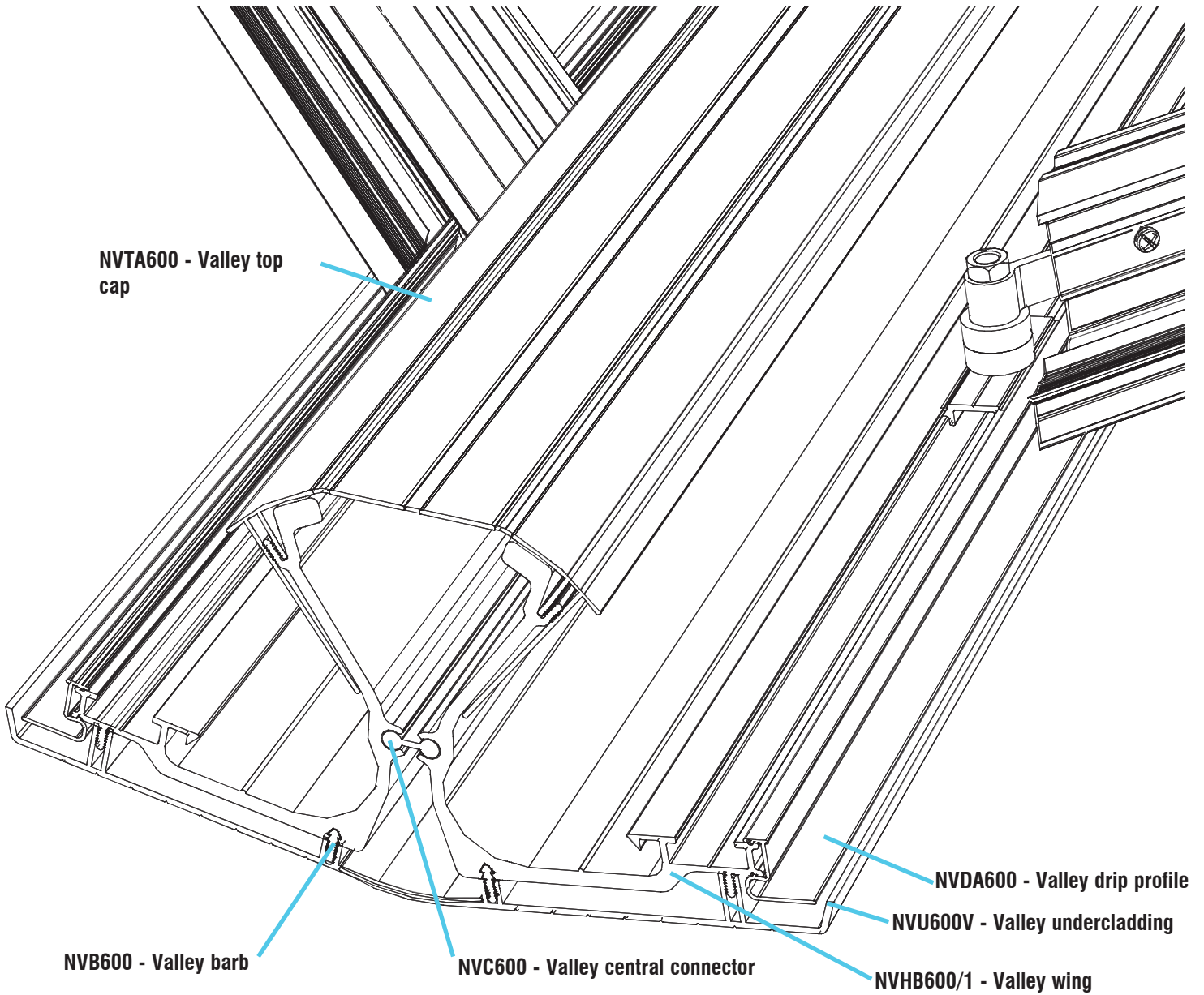

NVB - - - Valley barb

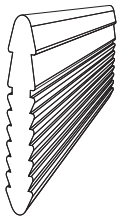

NVB600 VALLEY BARB 6M
(TWO PER VALLEY)

NVU - - - Valley undercladding V groove

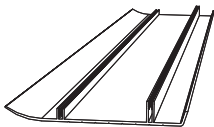

NVU600V VALLEY UNDERCLADDING 6M WHITE
(TWO PER VALLEY)

NVC - - - Valley central connector

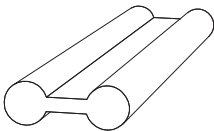

NVC600 VALLEY CENTRAL CONNECTOR 6M

VRK - - - Valley rafter kit

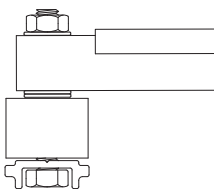

VRK002 VALLEY RAFTER KIT
VRK003 VALLEY RAFTER KIT STRUCTURAL

NVDA - - - Valley drip profile

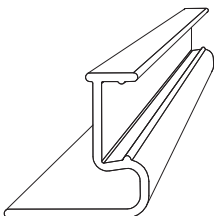

NVDA600 VALLEY DRIP PROFILE 6M

NVE 002 Valley end cap/fixing kit

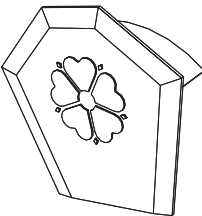

NVE002 VALLEY END CAP/FIXING KIT(4M/6M)
(INCLUDES - VSR001 PLASTIC SNAP RIVETS)

NVHB - - - Valley wing

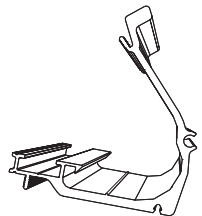

NVHB600/1 VALLEY WING 6M

NVTA - - - Valley top cap

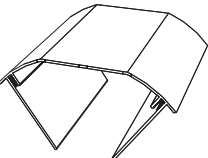

NVTA600 VALLEY TOP CAP 6M

SECTION 5 - Guttering

Rainwater disposal is essential and in this section are structural box gutters too

For further visual help with box gutter adaptor and rain water pipe outlet indentification, please turn to pages 33 & 34

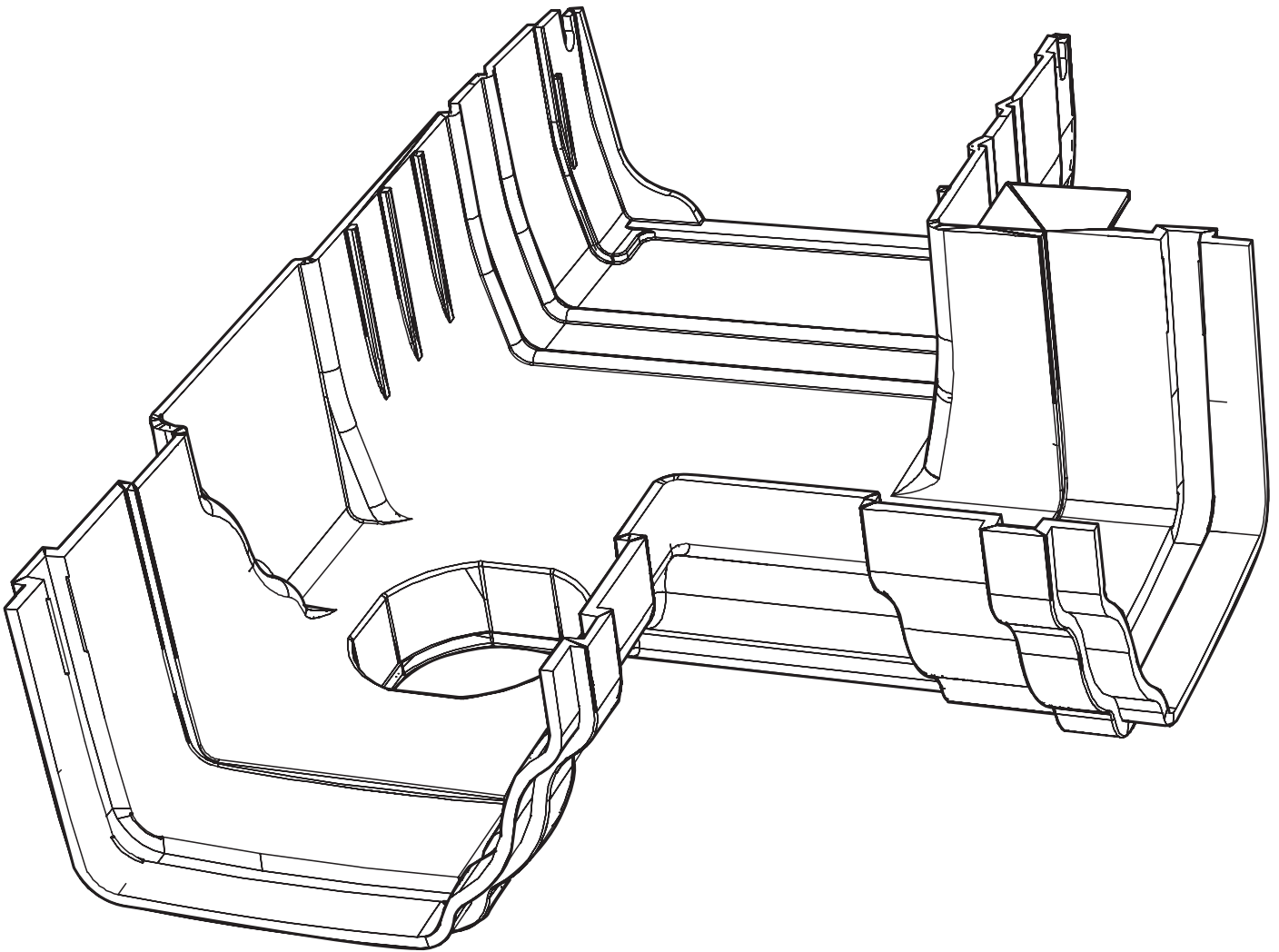

AAHA 001 Bolt Slot Attached Raised Back Box Gutter

AAHA001 BOLT SLOT ATTACHED TO HEAD OF RAISED BACK BOX GUTTER



BGI - - - Box Gutter Insulation

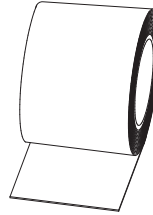

BGI422 INSULATION 4M ROLL - 165 b.g
 BGI622 INSULATION 6M ROLL - 165 b.g
 BGI432 INSULATION 4M ROLL - 265 b.g
 BGI632 INSULATION 6M ROLL - 265 b.g

AHB 001 165 Box Gutter Hanging Bracket

AHB001 165 BOX GUTTER HANGING BRACKET



BGRA 005 165mm Box Gutter Reinforcement (strap)

BGRA005/S 165MM REINFORCEMENT 50MM X 5

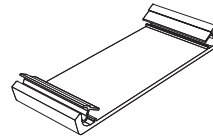

BAS 075BL Box gutter 75ml Tube of Sealant

BAS075BL BOXGUTTER 75ML TUBE OF SEALANT (Gutterbond)

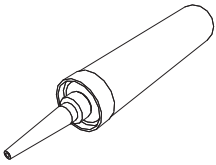

BST 001 Box Gutter Sealing Tape

BST001 BOX GUTTER SEALING TAPE



BES 001 Bottom Elbow Shoe (RWP)

BES001 BOTTOM ELBOW SHOE

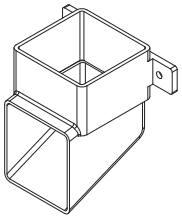

DBU - - - Decorative box gutter cladding

DBU600S 165MM CLADDING 6M
 DBUA600L 265MM CLADDING 6M

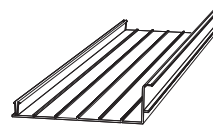

BGAA - - - Box Gutter Adaptors (SEE p40)

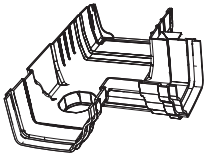

165MM ADAPTORS
 BGAA001L/1 STRAIGHT INLINE LEFT
 BGAA001R/1 STRAIGHT INLINE RIGHT
 BGAA002L/1 90 DEGREE LEFT
 BGAA002R/1 90 DEGREE RIGHT
 BGAA003L/1 90 WITH OUTLET LEFT
 BGAA003R/1 90 WITH OUTLET RIGHT
 BGAA004L/1 135WITH OUTLET LEFT
 BGAA004R/1 135WITH OUTLET RIGHT
 BGAA005L/1 INLINE OFFSET LEFT
 BGAA005R/1 INLINE OFFSET RIGHT
 BGAA007L/1 90 OFFSET LEFT
 BGAA007R/1 90 OFFSET RIGHT

265MM ADAPTORS
 BGAA261L/1 ASSY C/W OUTLET
 BGAA261R/1 ASSY C/W OUTLET
 BGAA262L/1 ASSY C/W RETURN
 BGAA262R/1 ASSY C/W RETURN
 BGAA263L/1 ASSY + STOP END
 BGAA263R/1 ASSY + STOP END

EET 001 Trunk Outlet (Cornice)

EET001 TRUNK OUTLET (CORNICED)

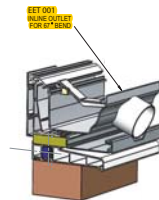

ESA - - - Marley Classic Gutter



ESA001L MARLEY CLASSIC GUTTER LEFT
 ESA001R MARLEY CLASSIC GUTTER RIGHT
 (STD 80MM OFFSET TO STEP ROUND STD BRICK)

FBM 600

FBM600 NEW PARABOLIC HEAD USED ON ALL IN HOUSE RAISED BACK BOX GUTTER



GAD - - - Gutter to RWP Adaptor

GAD001 GUTTER TO SQUARE RWP ADAPTOR
 GAD002 GUTTER TO ROUND RWP ADAPTOR
 (GUTTER OUTLET TO RWP AND RWP TO RWP JOINTER)

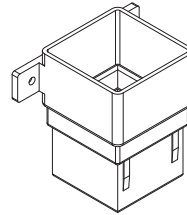

FGB 001 Flowline Gutter Bracket Screw Fix

FGB001 SCREW FIX FLOWLINE GUTTER BRACKET

GBLA 001 Gallows Bracket (265mm Box Gutter)

GBLA001 GALLOWS BRACKET 265 MM

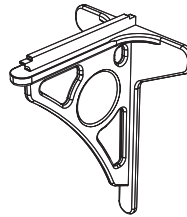

FIA 001 90 Deg Flowline Gutter Angle

FIA001 90 DEG FLOWLINE GUTTER ANGLE

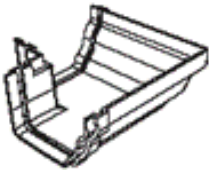

GBSA 001 Gallows Bracket (165mm Box Gutter)

GBSA001 GALLOWS BRACKET 165MM

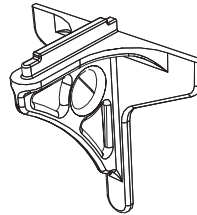

FJB 001 Gutter Jointer Flowline

FJB001 GUTTER JOINTER FLOWLINE



HOP 001 Hopper Head

HOP001 HOPPER HEAD



FRO 001 Running Outlet Flowline

FRO001 RUNNING OUTLET FLOWLINE



MEA 001 Classic Gutter External 90 Degrees

MEA001 GUTTER 4LT EXTERNAL 90 DEG

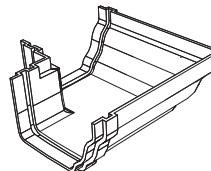

FSE - - - Stop End Outlet Flowline

FSE001 STOP END OUTLET FLOWLINE
 FSE002 STOP END (NOT HANDED)



MGB 002 Classic Gutter Screw on Bracket

MGB002 4LT SCREW ON GUTTER BRACKET

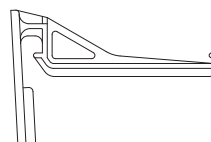

MGBB 001 Classic Gutter Eaves Beam Bracket

MGBB001 EAVES BEAM GUTTER BRACKET

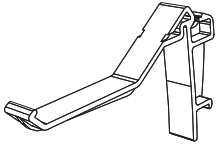

MGO 001 Special Gutter Outlet/Tank Fitting

MGO001 SPECIAL GUTTER OUTLET/TANK FITTING (DRILL & FIT)

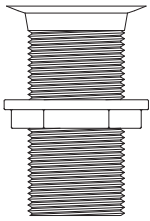

MGU - - - Classic Gutter

MGU400 GUTTER 4LT 4M
MGU600 GUTTER 4LT 6M

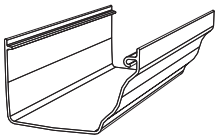

MGU - - - Classic Gutter Angle

MGU135 GUTTER 4LT 135 DEG ANGLE
MGU150 GUTTER 4LT 150 DEG ANGLE

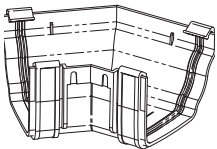

(FABRICATED VARIABLE ANGLES ARE AVAILABLE)

MIA 001 Classic Gutter Internal 90 Degrees

MIA001 GUTTER 4LT INT 90 DEG ANGLE

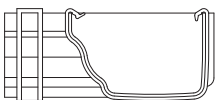

MJB 001 Classic Gutter Joint Bracket

MJB001 GUTTER 4LT JOINT BRACKET

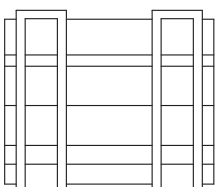

MRIA 001 Inline Running Outlet - On Eaves Beam

MRIA001 INLINE RUNNING OUTLET (2 X MJB001 REQUIRED)

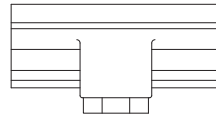

MRO 001 Running Outlet (Wall Mounted)

MRO001 RUNNING OUTLET (WALL MOUNTED)

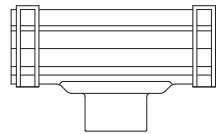

MRSA- - - Stopend Outlet - On Eaves Beam

MRSA001 STOPEND OUTLET LEFT
MRSA002 STOPEND OUTLET RIGHT

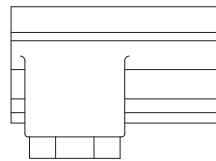

MSE - - - Classic Gutter Stop Ends

MSE001 GUTTER STOP END LEFT
MSE002 GUTTER STOP END RIGHT

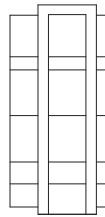

MSO - - - Classic Gutter Stop End Outlet (Wall Mounted)

MSO001 GUTTER STOP END OUTLET LEFT
MSO002 GUTTER STOP END OUTLET RIGHT

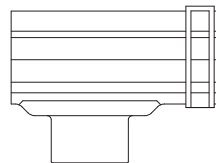

OET 090 Trunk Outlet 90°

OET090L/R 90° GUTTER TRUNK OUTLET

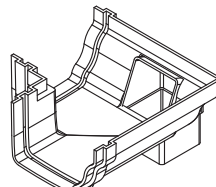

LEFT (DOWN FRONT LEFT CORNER POST)

MAY ALSO BE USED DOWN SIDE OF FRONT RIGHT CORNER POST (SHOWN). See page 34 for identification of exact needs.

PBSB - - - 165 Box Gutter Jointing Sleeve



PBSB030 165 BOX GUTTER JOINTING SLEEVE

RWP 250 Square Rainwater Pipe

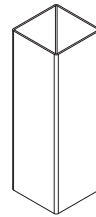

RWP250 RAINWATER PIPE 2.5M

RDP 068 Rainwater Pipe 67° Obtuse Round

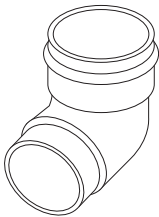

RDP068 PIPE 67° OBTUSE BEND ROUND

SSG - - - Trunk Outlet



SSG001 INLINE TRUNK OUTLET
SSG002 STOP END TRUNK OUTLET L&R

RWB 001 Offset Bend Kit

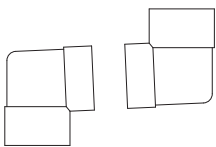

RWB001 OFFSET BEND KIT (SQUARE)

UFG 002/1 Elevated Front Box Gutter

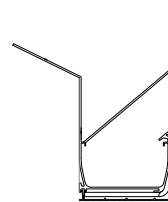

UFG002/1 ELEVATED FRONT BOX GUTTER

RWC 001 Downpipe Bracket (RWP)



RWC001 SQUARE DOWNPIPE BRACKET(2)

UZBGSB 001 Box Gutter Hanging Bbracket



UZBGSB001 BOX GUTTER HANGING BRACKET
(165MM BOXGUTTER ONLY)

RWO - - - Rainwater Pipe 67° Obtuse Square

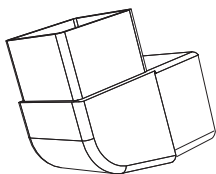

RW0001 PIPE 67 DEG OBTUSE BEND SQUARE
RW0087 PIPE 87 DEG OBTUSE BEND SQUARE

UZGU - - - Low Pitch Flowline Clip on Gutter Bracket

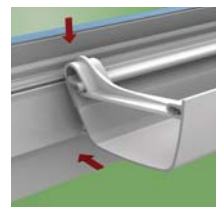

UZGU001 LOW PITCH FLOWLINE CLIP ON GUTTER BRACKET
UZGU--- LOW PITCH FLOWLINE GUTTER

RWP 001 Square Rainwater Pipe Branch

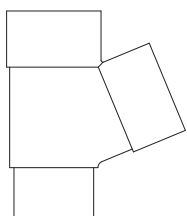

RWP001 RAINWATER PIPE BRANCH

UZRW - - - Round Downpipe Bracket Clip

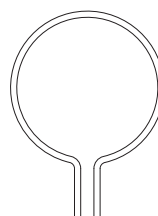

UZRW001W/1 DOWNPIPE BRACKET PIPE CLIP
(CONNECT D.P SHOW TO RWP)

UZRW - - - Round Downpipe Socket Clip

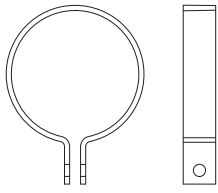

UZRW001W/2 DOWNPIPE BRACKET SOCKET CLIP
(CONNECT RWP TO HOST WALL)

UZRW - - - Round Downpipe Bracket Backplate

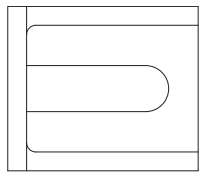

UZRW001W/3 DOWNPIPE BRACKET BACKPLATE
(TO CONNECT SOCKET CLIP TO HOST WALL)

UZRW 002 Round Downpipe Shoe

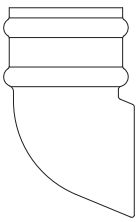

UZRW002W ROUND DOWNPIPE SHOE

UZRW 250 Round Downpipe



UZRW250W RAINWATER DOWNPIPE

VBGB - - - 165mm Box Gutter

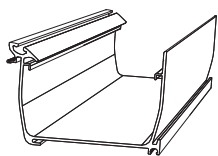

VBGB600PA VICTORIAN 165MM BOXGUTTER 6M

VWBA - - - 265mm Box Gutter

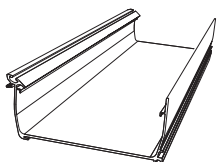

VWBA600/1 265MM BOX GUTTER ALUMINIUM 6M
VWBA600/3 265MM BOX GUTTER SLEEVE 6M

VWSA - - - 265mm Box Gutter Reinforcement Strap



VWSA001 265 BOX GUTTER REINFORCEMENT STRAP

SECTION 6 - Ancillaries

Included here are specific roof ancillaries such as the TBRK (Tie Bar Replacement Kit) which make the Classic system the clear winner - tried, tested, trusted.

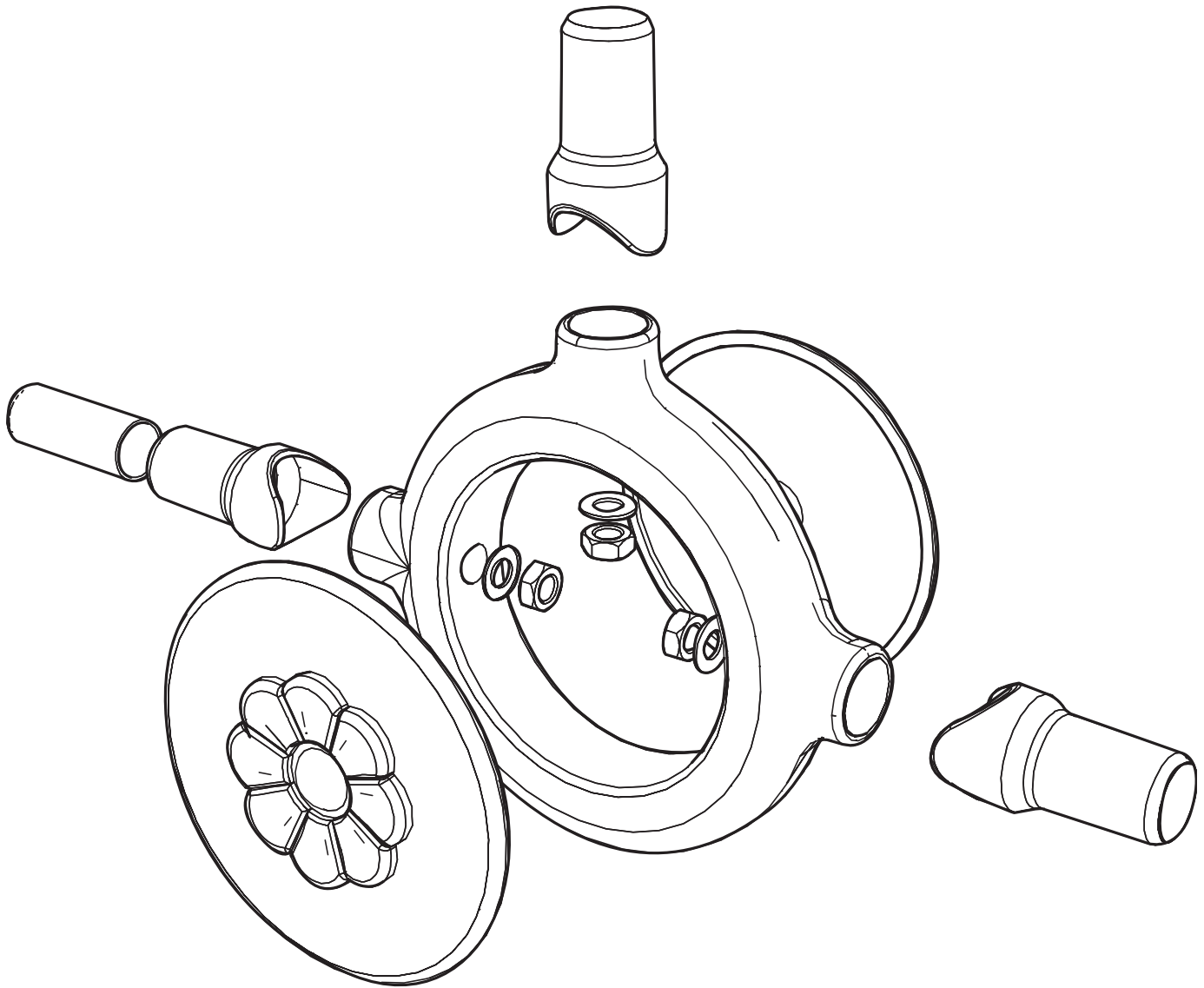

AMB - - - Aluminium Muntin

AMB--/25 ALUMINIUM MUNTIN
AMB--/25GR ALUMINIUM MUNTIN GREY



AVM 003 Roof vent motor (Actuator)

AVM003 ROOF VENT MOTOR (ACTUATOR)

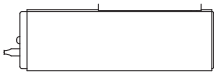

AVS 001 Roof vent motor (Switch)

AVS001 ROOF VENT MOTOR SWITCH

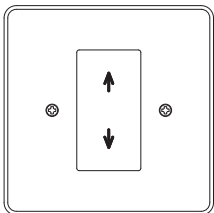

AVTD 002 Roof Vent pack (Automatic)

AVTD002 ROOF VENT AUTO PACK INCLUDING THERMOSTAT & RAIN SENSOR

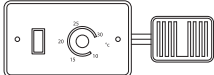

BRP - - - Opening Pole (Roof Vent)

BRP001 BRASS POLE (STD)
BRP001T BRASS POLE TELESCOPIC 2.5M
BRP002T BRASS POLE TELESCOPIC 4M
BRP001C CHROME POLE (STD)
BRP001M BRASS POLE LEAN-TO/SHORT

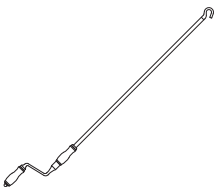

CVKA - - - Roof vent mechanical winder

CVKA001 MANUAL WINDER MECH BRASS
CVKA001C MANUAL WINDER MECH CHROME
CVKA002 MANUAL WINDER MECH (35MM) (BRASS ONLY)

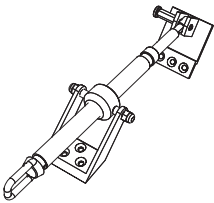

FBR 001 Fan Fixing Bracket

FBR001 FAN FIXING BRACKET



FM - - - Manual Fan

FMDC001AMW APOLLO FAN
FRDC001BMM VENUS FAN
FMDC001W ELEGANCE FAN
FMPE001CWB PRINCESS TRIO FAN
FMPT001BM TRADITIONAL FAN
FMPT001BW TRADITIONAL BLANC FAN



FR - - - Remotes for Fans

FRCA001 REMOTE CONTROL
FRDC001AMW APOLLO FAN REMOTE
FRDC001BMM VENUS FAN REMOTE
FRDC001W ELEGANCE FAN REMOTE
FRPE001CWB PRINCESS TRIO FAN REMOTE
FRPT001BM TRADITIONAL FAN REMOTE
FRPT001BW TRADITIONAL BLANC FAN REMOTE



LFF 001 Conservaflash - saddle flashing

LFF001 SADDLE FLASHING

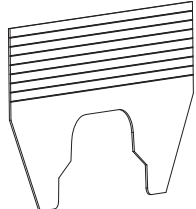

LFF 001/ Conservaflash - stepped units

LFF001/15L/R L/R STEPPED UNITS 10-15.9°
LFF001/20L/R L/R STEPPED UNITS 16-20.9°
LFF001/25L/R L/R STEPPED UNITS 21-25.9°
LFF001/30L/R L/R STEPPED UNITS 26-30.9°
LFF001/35L/R L/R STEPPED UNITS 31-35°

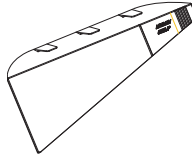

LFF - - - Conservaflash horizontal flashing 570mm

LFF057 HORIZONTAL FLASHING 570MM
LFF090I INTERNAL 90° CORNER FLASHING

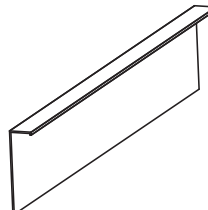

LFS - - -

Conservaflash soaker

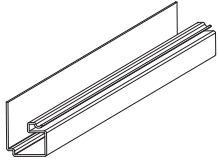

- LFS200 CONSERVAFLASH SOAKER 2M
- LFS250 CONSERVAFLASH SOAKER 2.5M
- LFS300 CONSERVAFLASH SOAKER 3M
- LFS400 CONSERVAFLASH SOAKER 4M
- LFS600 CONSERVAFLASH SOAKER 6M

PMB 001

Muntin bar

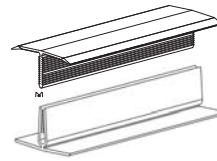

- PMB300/1 MUNTIN BAR (ADJOINING SEALED UNITS ONLY) TOP SECTION
- PMB300/2 BOTTOM SECTION

LPLL - - -

Lightboard



- LPLL240 FKIT 2.4M LIGHTBOARD
- LPLL120 FKIT 1.2M LIGHTBOARD
- LPLL240 HKIT 2.4M LIGHTBOARD
- LPLL120 HKIT 1.2M LIGHTBOARD

PRV - - -

Roof vent 24mm (up to 800x800mm)

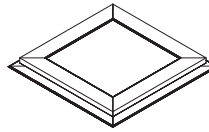

- PRV001-24 ROOF VENT 24MM UPTO 800 X 800 NO MECHANISM
- PRV002-24 ROOF VENT 24MM OVER 800 X 800 NO MECHANISM
- PRV001-35* ROOF VENT 35MM UPTO 800 X 800 NO MECHANISM
- PRV002-35* ROOF VENT 35MM OVER 800 X 800 NO MECHANISM

*PLEASE NOTE - BEADS SUPPLIED FOR THE SASH ARE FOR 25MM GLAZING THESE ARE NOT STOCK ITEMS AND NEED FABRICATING BY ULTRAFRAME

LVLA 001

Downlights

- LVLA001 EYEBALL SPOTLIGHT (BRASS) WITH TRANSFORMER AND WHITE MOUNTING COLLAR
- LVLA001B EYEBALL SPOTLIGHT (BRASS) WITH TRANSFORMER AND BROWN MOUNTING COLLAR
- LVLA001CB EYEBALL SPOTLIGHT (CHROME) WITH TRANSFORMER AND BROWN MOUNTING COLLAR
- LVLA001CW EYEBALL SPOTLIGHT (CHROME) WITH TRANSFORMER AND WHITE MOUNTING COLLAR

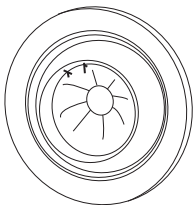

RVA 024

Roof Vent Packer

- PVA024 ROOF VENT PACKER



RVDA - - -

Roof Vent Bolster Cladding

- PVDA ROOF VENT BOLSTER CLADDING



MMBB 001

Roof Vent Mounting Bracket

- MMBB001 ROOF VENT MOUNTING BRACKET



RVR - - -

Roof Vent Bolster - Aluminium

- PVR ROOF VENT BOLSTER



NCGS - - -

Sealant



- NCGS001B MS POLYMER SEALANT
- (MUST BE USED ON SELF CLEAN GLASS)

RVS - - -

Roof Vent Bolster Cladding

- RVS MANUAL WINDER BRACKET
- RVS001 BRACKET SCREW 4.8 X 19



PVSB - - - Roof Vent Bead

PVSB--- ROOF VENT BEAD

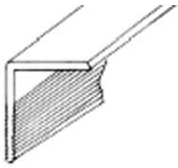

THD 001 T Bar Spanner

THD001 10MM T BAR SPANNER
THD002 13MM T BAR SPANNER



RVSA - - -

RVSA002 BOLSTER SCREW 4.8 X 32
RVSA013 RE-INFORCING SCREW M4 X 13

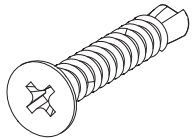

TTB - - - Tie bar threaded bar

TTB200 TIE BAR THREADED BAR 2M
TTB300 TIE BAR THREADED BAR 3M

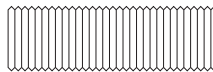

TBBB 001 Tie bar bracket and bolt covers

TBBB001 TIE BAR BRACKET AND BOLT COVERS

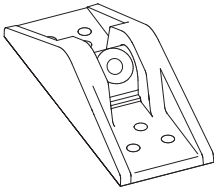

TBC - - - Tie bar conduit

TBC200 TIE BAR CONDUIT 2M
TBC300 TIE BAR CONDUIT 3M

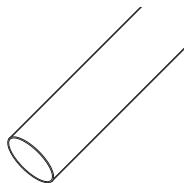

TFKA - - - Tie bar fixing kit

TFKA003 3 WAY TIE BAR FIXING KIT
TFKA005 5 WAY TIE BAR FIXING KIT



TFSA 001 Tie bar bracket bolt

TFSA001 TIE BAR BRACKET BOLT 24MM AND NUT
(USED ONLY WHEN 7 SERIES BAR IS REINFORCED)

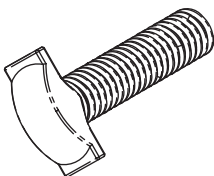

SECTION 8 - Marley Classic Box Gutter Adaptors

165mm

BGAA001L/1(B)(D)(K)

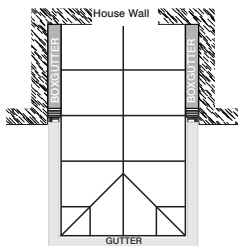
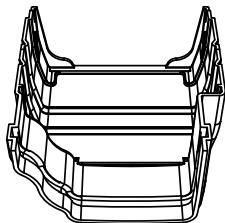

BGAA001R/1(B)(D)(K)

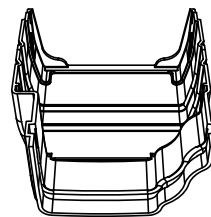

BGAA002L/1(B)(D)(K)

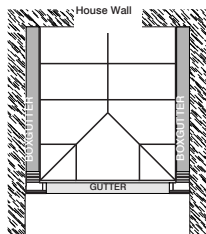
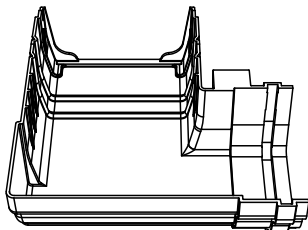

BGAA002R/1(B)(D)(K)

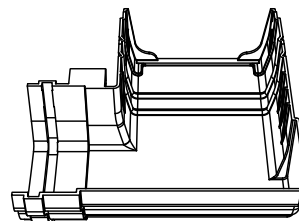

BGAA003L/1(B)(D)(K)

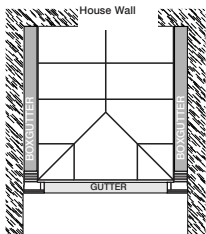
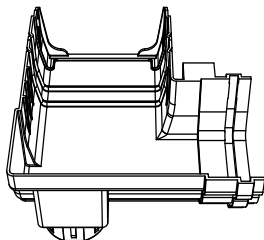

BGAA003R/1(B)(D)(K)

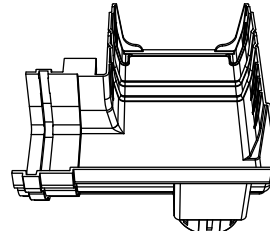

BGAA004L/1(B)(D)(K)

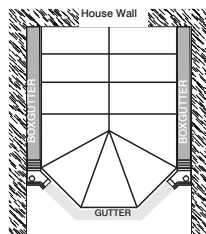
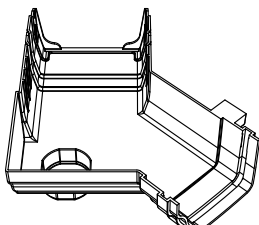

BGAA004R/1(B)(D)(K)

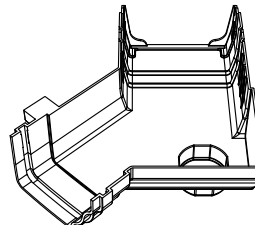

BGAA005L/1(B)(D)(K)

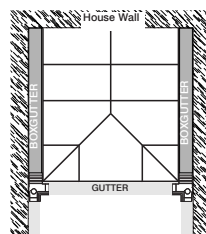
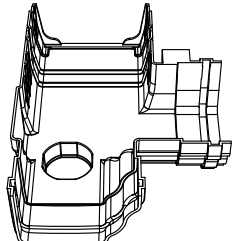

BGAA005R/1(B)(D)(K)

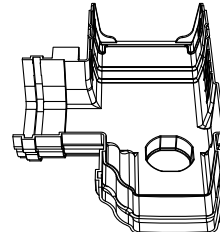

BGAA007L/1(B)(D)(K)

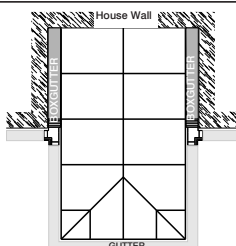
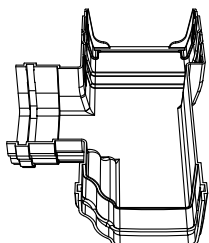

BGAA007R/1(B)(D)(K)

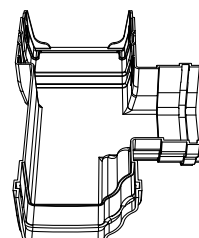

265mm

BGAA261L/1

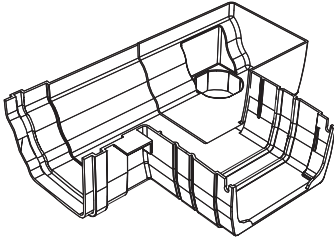

BGAA261R/1

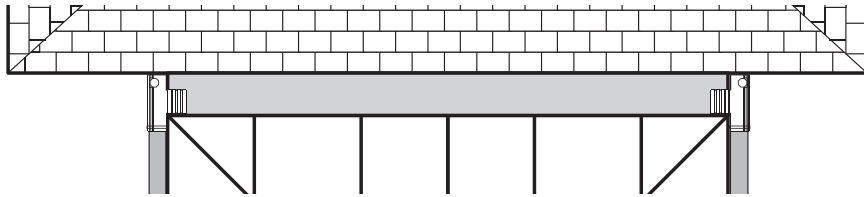
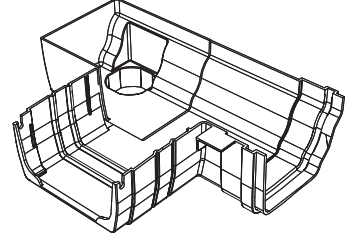

BGAA262L/1

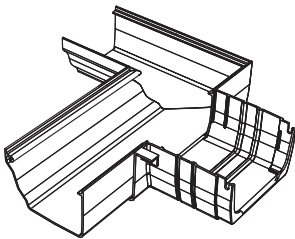

BGAA262R/1

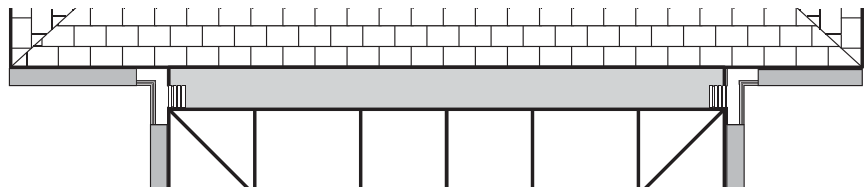
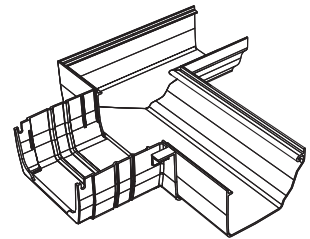

BGAA263L/1

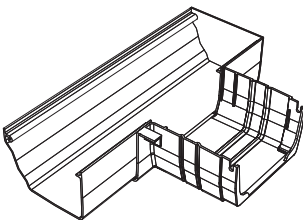

BGAA263R/1

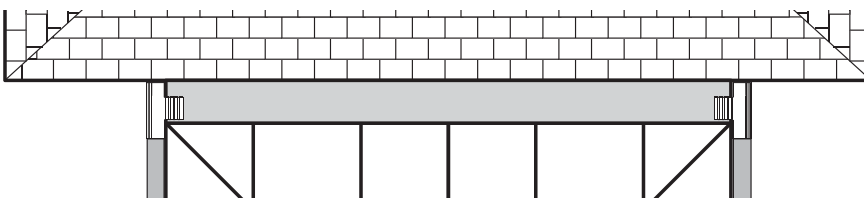
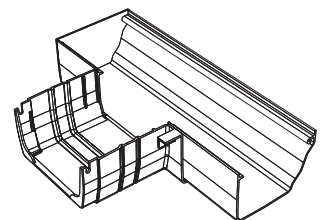

LEFT HAND

RIGHT HAND

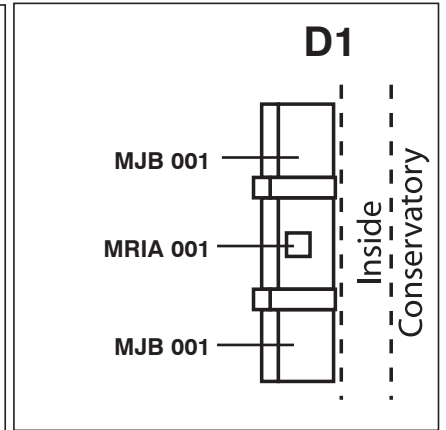
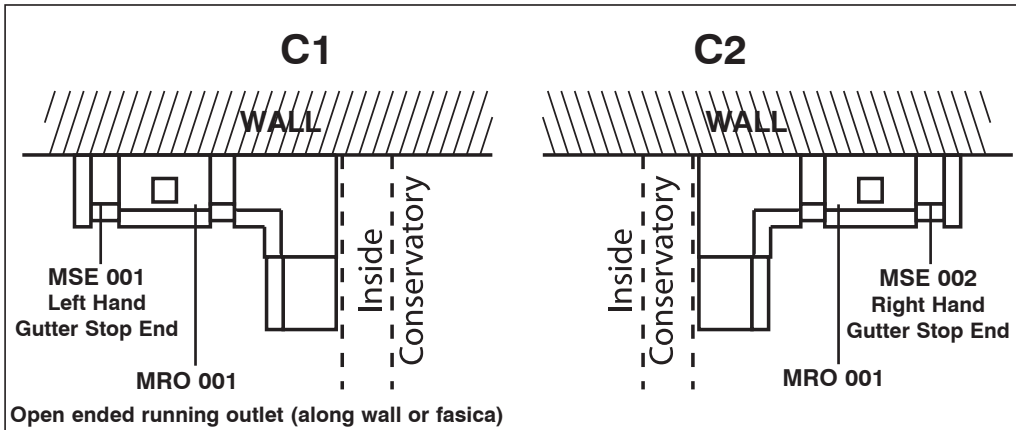
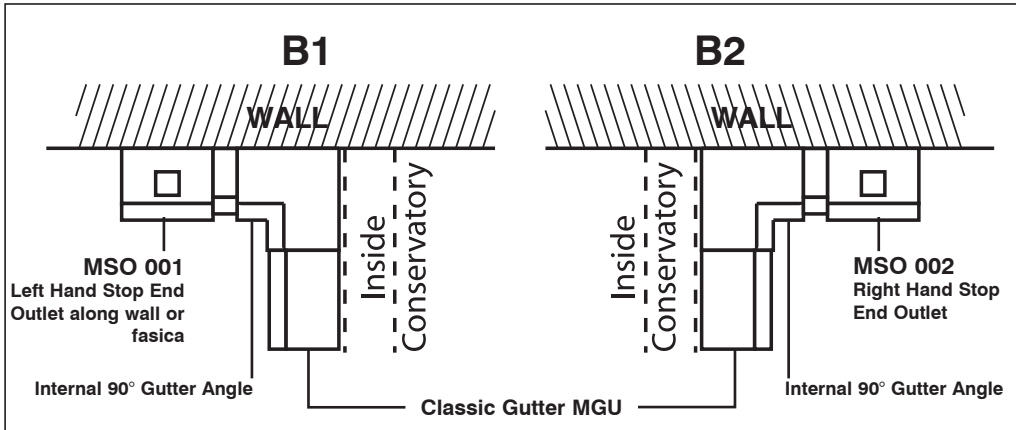
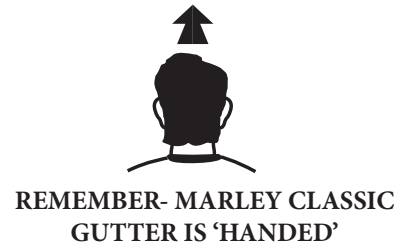
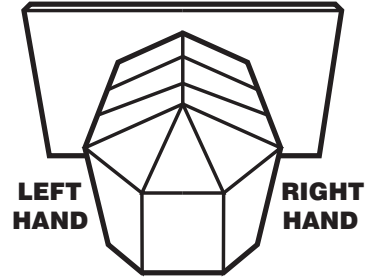
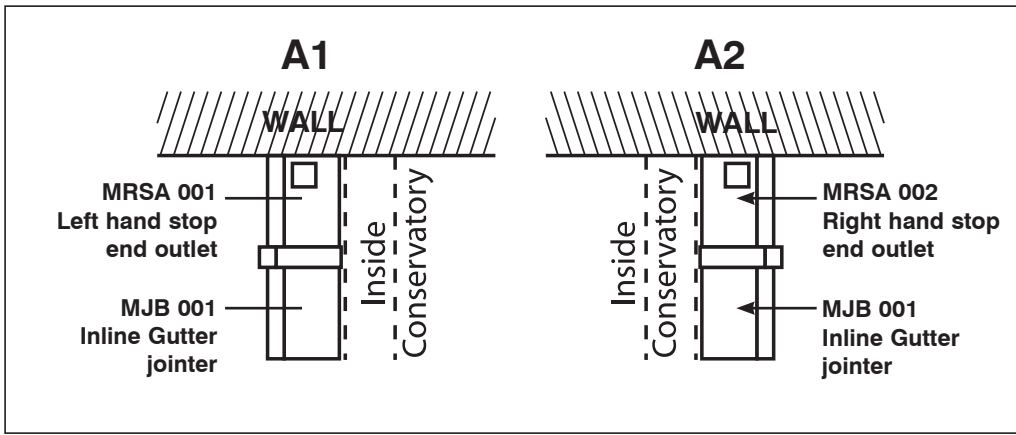

ELEPHANT'S TRUNKS

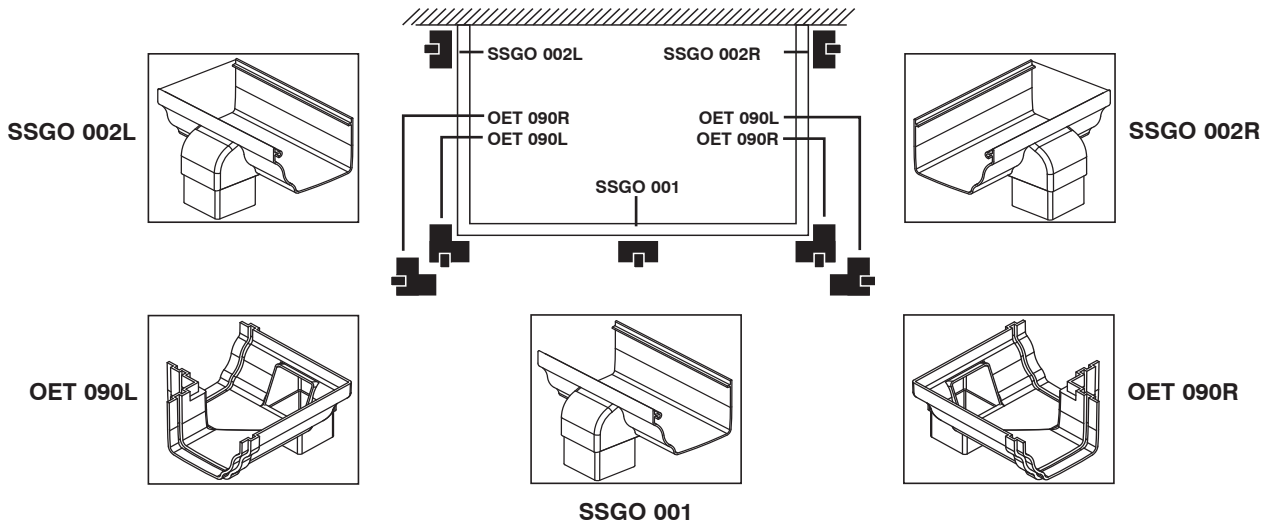

Index

CODE	DESCRIPTION	PAGE	CODE	DESCRIPTION	PAGE
AAHA001	BOLT SLOT ATTACHED RAISED BACK B/GUT	P31	CCT600W/35	TRANSOM CAPPING 35MM	P24
AAHA600/1	SLIDE IN BOLT SLOT FOR PWP 6M	P13	CCT001W	DOME CHAMBERED TRANSOM END CAP	P24
ACC001	FINIAL ADAPTOR	P13	CNL050	BAROQUE CRESTING	P13
ACC002	FINIAL ADAPTOR FIXING	P13	CPP050	ELIZABETHAN CRESTING	P13
ACC050	CRESTINGS	P13	CRC090	EXTERNAL (270 DEG) RADIUS END COVER	P13
ACF001	BALL FINIAL	P13	CRE050	CLASSIC CRESTINGS	P13
ACP---/1	RIDGE TOP CAP	P13	CRN---/1	LOWER CORNICE SECTION (USED WITH STANDARD EAVES BEAM)	P4
ACP001	EXTERNAL RADIUS END COVER	P13	CRN---/2	MIDDLE CORNICE SECTION	P4
ACP002	BRUSH- EXT RADIUS END	P13	CRN---/3	UPPER CORNICE SECTION	P4
ACP003	RADIUS END CLAMP WASHER	P13	CRN001	CLEAT (CONNECTING CORNICE CORNERS)	P4
ACP004	RADIUS END FLASHING TRIM	P13	CRN002	SUPPORT BRACKET - CORNICE GUTTER	P4
AGC---/25	GEORGIAN TOP CAP- ALUMINIUM	P23	CRN003	GABLE/ LEAN TO END PLATE- CORNICE	P4
AGP---/25	GLAZING END PROFILE	P4	CRN005	TIE WIRE (USED OFF TRANSOM/JACK)	P4
AGP---/25GR	GLAZING END PROFILE GREY	P4	CRN006	CLEAT SCREW M4 X 10	P4
AGS250	QLON GASKET	P23	CRN007	SECTION SCREW 4.8 X 16	P4
AHB001	165 BOX GUTTER HANGING BRACKET	P31	CRN008	END PLATE SCREW 3.5 X 13	P4
AHC---/1	HALF RIDGE TOP CAP	P13	CRN010	TIE WIRE SCREW	P4
AHC001L	HALF RIDGE RADIUS END COVER- LEFT	P13	CRN012	LONG CORNER THE WIRE (HIP BARS)	P4
AHC001R	HALF RIDGE RADIUS END COVER- RIGHT	P13	CRN014	CORNICE INLINE OUTLET COVER	P4
AHC002	BRUSH- HALF RIDGE EXT RAD END COVER	P13	CRN090	90 DEGREE CORNICE COVER CORNERS	P4
ALC---/1	LEAN TO CLOAKING TRIM- ALUMINIUM	P23	CRN135	135 DEGREE CORNICE COVER CORNERS	P4
ALP---/1	LOW PROFILE CRESTINGS	P13	CRN180	180 DEGREE CORNICE COVER CORNERS	P4
AMB--/25	ALUMINIUM MUNTIN	P37	CRS001	LANTERN HEADER SCREW 4.2 X 13	P4
AMB--/25GR	ALUMINIUM MUNTIN GREY	P37	CRU090	INTERNAL (270 DEG) RADIUS END COVER	P14
AOC---/25	TRANSOM TOP CAP- ALUMINIUM	P23	CSL050	TUDOR CRESTING	P14
ASC---/25	STARTER BAR TOP CAP- ALUMINIUM	P23	CUD600	LOW PROFILE CRESTING 6M	P14
ATC---/25	TRANSOM TOP CAP- ALUMINIUM	P23	CVKA001	MANUAL WINDER MECH BRASS	P37
AVBA600W/1	VERANDA BEAM/ GUTTER	P4	CVKA001C	MANUAL WINDER MECH CHROME	P37
AVBA001	VERANDA BEAM GASKET	P4	CVKA002	MANUAL WINDER MECH (35MM) (BRASS ONLY)	P37
AVBA004	VERANDA BEAM BAR TO BEAM BRACKET	P4	DBC600	ROUND EDGE GLZ BAR U/CLAD 6M	P24
AVBA005	VERANDA BEAM GLASS CLIP BRACKET	P4	DBU600S	165MM CLADDING 6M	P31
AVBA006	BLACK VINYL END CAP	P4	DBUA600L	265MM CLADDING 6M	P31
AVBA010	VLACK VINYL POST CAP	P4	DCM001	DECORATIVE END CAP ROSE MOTIF	P24
AVM003	ROOF VENT MOTOR (ACTUATOR)	P37	DCM001	INSERT FOR DEC FASCIA CORNERS	P4
AVS001	ROOF VENT MOTOR SWITCH	P37	DFCA001	INLINE JOINTER	P4
AVTD002	ROOF VENT AUTO PACK	P37	DFCA090A	ADJUSTABLE CORNER	P4
BAS075BL	BOXGUTTER 75ML TUBE OF SEALANT	P31	DFCA090I	90 DEGREE INTERNAL CORNER	P4
BEC001	BOLSTER BAR END CAP	P23	DFCA135	135 DEGREE CORNER	P4
BES001	BOTTOM ELBOW SHOW	P31	DFCA150	150 DEGREE CORNER	P4
BFK020	BOLSTER BAR FIXING KIT PACK	P23	DFS650/2	TRIM TO TOE OF SUPER DUTY EAVES BEAM	P4
BFS001	BOLSTER BAR FIXING KIT	P23	DGCE010	GLASS CLIP PACK (5 LEFT, 5 RIGHT)	P24
BFNA004	SCEPTRE MOULDED FINAL	P13	DHC600	SQUARE EDGED HIP BAR U/CLAD 6M	P24
BGAA001L/1	STRAIGHT INLINE LEFT	P31	DTA600	DENTIL ADD ON 58-64MM FRAMES	P4
BGAA001R/1	STRAIGHT INLINE RIGHT	P31	DTA600L	DENTIL ADD ON 65-70MM FRAMES	P4
BGAA002L/1	90 DEGREE LEFT	P31	DTM002	DENTIL MOULDING CLIP FIT	P4
BGAA002R/1	90 DEGREE RIGHT	P31	DTM004	DENTIL MOULDING ADHESIVE FIX	P4
BGAA003L/1	90 WITH OUTLET LEFT	P31	DPCA010	POLYCARBONATE CLIP KIT	P24
BGAA003R/1	90 WITH OUTLET RIGHT	P31	DPA001	DIFFERENTIAL PITCH- RIDGE ADAPTOR	P14
BGAA004L/1	135 WITH OUTLET LEFT	P31	DPA002	DIFFERENTIAL PITCH- RIDGE SPACER BUSH	P14
BGAA004R/1	135 WITH OUTLET RIGHT	P31	EBCA001	CLEAT INLINE	P4
BGAA005L/1	INLINE OFFSET LEFT	P31	EBCA090	CLEAT 90 DEGREE	P4
BGAA005R/1	INLINE OFFSET RIGHT	P31	EBCA135	CLEAT 135 DEGREE	P4
BGAA007L/1	90 OFFSET LEFT	P31	EBCA150	CLEAT 150 DEGREE	P4
BGAA007R/1	90 OFFSET RIGHT	P31	EBT001	EAVES BEAM CLEAT TAPTITE M5 X 12	P4
BGAA261L/1	ASSY C/W OUTLET	P31	ECF001	END CAP FIXING FIT (50)	P5
BGAA261R/1	ASSY C/W OUTLET	P31	EECA001SL/R	EAVES BEAM END PLUG	P5
BGAA262L/1	ASSY C/W RETURN	P31	EET001	TRUCK OUTLET (CORNICE)	P31
BGAA262R/1	ASSY C/W RETURN	P31	EFSA021	ENDCAP FIXING SCREW	P24
BGAA263L/1	ASSY + STOP END	P31	ESA001L	MARLEY CLASSIC GUTTER LEFT	P31
BGAA263R/1	ASSY + STOP END	P31	ESA001R	MARLEY CLASSIC GUTTER RIGHT	P31
BGI422	INSULATION 4M ROLL - 165 B.G	P31	FBM600	NEW PARABOLIC HEAD USED ON RAISED B/GUT	P32
BGI622	INSULATION 6M ROLL - 165 B.G	P31	FBR001	FAN FIXING BRACKET	P37
BGI432	INSULATION 4M ROLL - 265 B.G	P31	FBG001	FLOWLINE GUTTER BRACKET SCREW FIX	P32
BGI4632	INSULATION 6M ROLL - 265 B.G	P31	FIA001	90 DEG FLOWLINE FUTTER ANGLE	P32
BGRA005/S	165MM REINFORCEMENT 50MM X 5	P31	FIR/2NT	FIRRING TOP CAP (USED WITH LCTB)	P5
BRP001	BRASS POLE (STD)	P37	FIR600/2NT	FIRRING PIECE CAPPING 6M NO TAPE	P25
BRP00T	BRASS POLE TELESCOPIC 2.5M	P37	FIN004	CLASSIC FINIAL	P14
BRP02T	BRASS POLE TELESCOPIC 4M	P37	FIN004L	CLASSIC FINIAL (TO SUIT WOK)	P14
BRP001C	CHROME POLE (STD)	P37	FJB001	GUTTER JOINTER FLOWLINE	P32
BRP001M	BRASS POLE LEAN-TO/SHORT	P37	FLN001	FLANGE NUT (7MM HOLES)	P5
BST001	BOX GUTTER SEALING TAPE	P31	FLNS001	SPIGUT NUT (9MM HOLES)	P5
CAPA6011	GLAZING BAR TOP CAP STARTER	P23	FLY620-24	FLYMESH STRIP- FULL RIDGE 24MM 6.2M	P14
CAPA604	GLAZING BAR TOP CAP VIC/TRANSOM	P23	FMDC001AMW	APOLLO FAN	P37
CAPA606	GLAZING BAR TOP CAP GEORGIAN	P23	FMDC001BMM	VENUS FAN	P37
CCA600W/25	TRANSOM CAPPING 25MM	P23	FMDC001W	ELEGANCE FAN	P37
CCA600W/35	TRANSOM CAPPING 35MM	P23	FMPE001CWB	PRINCESS TRIO FAN	P37
CCE001LW	CHAMBERED STARTER BAR END CAP (L)	P23	FMPT001BM	TRADITIONAL FAN	P37
CCE001RW	CHAMBERED STARTER BAR END CAP (R)	P23	FMPT001BW	TRADITIONAL BLANC FAN	P37
CCE002LW	CHAMBERED END CAP GABLE/ LEAN TO (L)	P24	FRCA001	REMOTE CONTROL	P37
CCE002RW	CHAMBERED END CAP GABLE/ LEAN TO (R)	P24	FRDC001AMW	APOLLO FAN REMOTE	P37
CCE050	RENAISSANCE CRESTING 500MM X 2	P13	FRDC001BMM	VENUS FAN REMOTE	P37
CCE100	RENAISSANCE ADAPTOR	P13	FRDC001W	ELEGANCE FAN REMOTE	P37
CCG001W	CHAMBERED GEORGIAN END CAP	P24	FRPE001CWB	PRINCESS TRIO FAN REMOTE	P37
CCG600W/25	GEORGIAN CAPPING 25MM	P24	FRPT001BM	TRADITIONAL FAN REMOTE	P37
CCG600W/35	GEORGIAN CAPPING 35MM	P24	FRPT001BW	TRADITIONAL BLANC FAN REMOTE	P37
CCS600W/25	CHAMBERED STARTER BAR TOP CAP 25	P24	FRO001	RUNNING OUTLET FLOWLINE	P32
CCS600W/35	CHAMBERED STARTER BAR TOP CAP 35	P24	FSE001	STOP END OUTLET FLOWLINE	P32
CCT600W/25	TRANSOM CAPPING 25MM	P24			

Index

CODE	DESCRIPTION	PAGE	CODE	DESCRIPTION	PAGE
FSE002	STOP END (NOT HANDED)	P32	KGR002UT	GEORGIAN SEP END COVER LARGE UNTRIM	P17
FUD001	LOW PROFILE FINIAL	P14	KHA001L	HR RAD END FIXING PLATE LEFT	P17
FWE001/1	FULL WOK EXTERNAL CAPPING	P14	KHA001R	HR RAD END FIXING PLATE RIGHT	P17
FWF020-25	FULL WOK FOAM 20-25	P14	KHB600/35	HALF RIDGE ALUM BAFFLE SUPPORT WING	P17
FWF030-35	FULL WOK FOAM 30-35	P14	KHC600	HALF RIDGE TOP CAPPING 6M	P17
FWI001	FULL WOK INTERNAL CAPPING	P14	KHF001	RIDGE/HALF RIDGE CAPPING JOINTER	P17
GAC001L	CORNER LEFT(BOLT SLOT RETURN)	P5	KHG015L-21	15DEG GEORGIAN 21TRIM LEFT	P17
GAC001R	CORNER RIGHT(BOLT SLOT RETURN)	P5	KHG015R-21	15DEG GEORGIAN 21TRIM RHT	P17
GAB001	GUTTER TO SQUARE RWP ADAPTORY	P32	KHG025L-21	25DEG GEORGIAN 21TRIM LEFT	P17
GAB002	GUTTER TO ROUND RWP ADAPTORY	P32	KHG025R-21	25DEG GEORGIAN 21TRIM RHT	P17
GBE400	ALUMINIUM GABLE BEAM 4M	P5	KHI001L	HR UNDER CAP SM RADIUS LEFT	P17
GBE650	ALUMINIUM GABLE BEAM 6.5M	P5	KHI001R	HR UNDER CAP SM RADIUS RIGHT	P17
GBC600	INT CLADDING 6M (PWLA)	P14	KHI002L	HR UNDER CAP LRG RADIUS LEFT	P17
GBCB600C	GLAZING BAR CLADDING 6M WHITE	P25	KHI002R	HR UNDER CAP LRG RADIUS RIGHT	P17
GBIA010	GABLE INFILL WEDGE - 10°	P5	KHI003L	HR UNDER CAP SM RADIUS LEFT	P17
GBIA015	GABLE INFILL WEDGE - 15°	P5	KHI003R	HR UNDER CAP SM RADIUS RIGHT	P17
GBIA020	GABLE INFILL WEDGE - 20°	P5	KHI004L	HR UNDER CAP LRG RADIUS LEFT	P17
GBIA025	GABLE INFILL WEDGE - 25°	P5	KHI004R	HR UNDER CAP LRG RADIUS RIGHT	P17
GBIA030	GABLE INFILL WEDGE - 30°	P5	KHL001	HALF RIDGE END CAP (LEFT)	P17
GBLA001	GALLOWS BRACKET 265MM	P32	KHM600	HALF RIDGE MAIN BODY 6M	P18
GBR500	GABLE BEAM REINFORCEMENT 5M	P5	KHR001	HALF RIDGE END CAP (RIGHT)	P18
GBR650	GABLE BEAM REINFORCEMENT 6.5M	P5	KHS060	HALF RIDGE STRUCTURAL CARRIAGE	P18
GBSA001	GALLOWS BRACKET 165MM	P32	KHU600	UNDERCLADDING 6M WH	P18
GCRA002	GLAZING BAR TOP CAP REMOVAL TOOL	P25	KHV015L-21	15DEG VICTORIAN 21TRIM LFT	P18
GEC650	GABLE BEAM TOP CLADDING 6.5M	P5	KHV015R-21	15DEG VICTORIAN 21TRIM RHT	P18
GIE001	GABLE INFILL WEDGE END CAP	P5	KHV025L-21	25DEG VICTORIAN 21TRIM LFT	P18
HCG003	15-20° GEORGIAN HALF WOK CAP INC CLIPS	P14	KHV025R-21	25DEG VICTORIAN 21TRIM RHT	P18
HCG004	25-30° GEORGIAN HALF WOK CAP INC CLIPS	P14	KJB001	JOINT BRACKET KIT 15°	P18
HCV003	5-20° VICTORIAN HALF WOK CAP INC CLIPS	P15	KJB002	JOINT BRACKET KIT 20-35°	P18
HCV004	25-30° VICTORIAN HALF WOK CAP INC CLIPS	P15	KL001	ROSE LOCKING FIXING BUTTON	P18
HOP001	HOPPER HEAD	P32	KMB60035/15/1	RIDGE BODY 15DEG MK5	P18
HRP001	HALF RIDGE ADAPTOR SMALL	P15	KMB60035/20/1	RIDGE BODY 20DEG MK5	P18
HRP002	HALF RIDGE ADAPTOR MAIN PLATE	P15	KMB60035/25/1	RIDGE BODY 25DEG MK5	P18
HWF005-15	HALF WOK FOAM	P15	KMB60035/30/1	RIDGE BODY 30DEG MK5	P18
HWF020-25	HALF WOK FOAM 20-25	P15	KMB60035/35/1	RIDGE BODY 35DEG MK5	P18
HWF030-35	HALF WOK FOAM 30-35	P15	KMB60035/40/1	RIDGE BODY 40DEG MK5	P18
IRK001	INTER RAFTER TENNON	P25	KOB002	VENTILATION OPERATION BUTTON	P18
IRK002	STRUCTURAL JACK RAFTER BASE KIT	P25	KRA001L	BACK PLATE 15°-30°	P18
IRK003	INTER RAFTER WEATHERING SHIELD	P25	KRA001R	BACK PLATE 15°-30°	P18
IRK004	EXTENDED INTER RAFTER KIT	P25	KRAA/015/2	15° BOLT-ON RIDGE PLATE - SLOTTED END	P18
IRK005	FLASHING TRIM- RUNBER	P25	KRAA/020/2	20° BOLT-ON RIDGE PLATE - SLOTTED END	P18
JRKA001/2	JACK RAFTER CHANNEL INFIL 15MM	P25	KRAA/025/2	25° BOLT-ON RIDGE PLATE - SLOTTED END	P18
JRKA002	JACK RAFTER KIT (7)	P25	KRAA/030/2	30° BOLT-ON RIDGE PLATE - SLOTTED END	P18
JRKA003	JACK RAFTER KIT 7+ REINF BAR	P25	KRAA/035/2	35° BOLT-ON RIDGE PLATE - SLOTTED END	P18
JRKA004/1	M4 X 12 PZ PAN	P25	KRAA/040/2	40° BOLT-ON RIDGE PLATE - SLOTTED END	P18
JRKA004/3	M6 FM B PLAIN WASHER	P25	KRB600/35BL	RAIN BAFFLE BACK SECTION 35MM	P18
KAC035	RIDGE CARRIAGE	P15	KRSB637/16L	7 SE'S 25MM LOW PITCH 6.3M	P18
KBC075	CROSS BRACE 20 DEG 75MM	P15	KRSB637/16S	7 SE'S 25MM STEEP PITCH 6.3M	P18
KBC075-15	CROSS BRACE 15 DEG 75MM	P15	KRSB637/32L	7 SE'S 35MM LOW PITCH 6.3M	P18
KBC300	JOINT PLATE 300MM 20-35 DEG	P15	KRSB637/32S	7 SE'S 35MM STEEP PITCH 6.3M	P18
KBC300-15	JOINT PLATE 300MM 15 DEG	P15	KSLD001	SPEEDLOK FOR 7 SERIES BARS	P25
KBEA001	UNDERCLADDING EXTENSION BRACKET	P15	KSSA002	SPEEDLOK KIT FOR 7 SERIES G/BAR	P25
KBF001	UNDERCLADDING BRACKET	P15	KTBA001/1	RIDGE T BOLT	P19
KSB001	CROSS BRACE SCREW 10 X 3/8	P15	KTBA001/2	FIXING WEDGE	P19
KBU600	UNDERCLADDING 5.97MM WHI	P15	KVRA001	SMALL RAD END UNDERCLADDING	P19
KCG003	15-20 DEG GEORG END CAPPING INC CLIPS	P15	KVRA002	LRG RAD END UNDERCLADDING	P19
KCG004	25-30 DEG GEORG END CAPPING INC CLIPS	P15	KVRA002UT	LRG RAD END UNDERCLAD UNTRIMMED	P19
KCP600/1	EXT RIDGE CAPPING SECTION 5.98M	P15	LCP001L/R	LOW PITCH LEAN TO EAVES END CAP BLOCK	P6
KCS060	RIDGE TOP CARRIAGE 60MM (10)	P16	LCSS200/1	COMPRESSION STRUT 2M	P6
KCS300	RIDGE TOP CARRIAGE 300MM	P16	LCSS200/W	COMPRESSION STRUT SLEEVE 2M	P6
KCT001/1	RIDGE TOP CAP INLINE JOINTER	P16	LCTB600	LEAN-TO CLOCK TRIM 6M	P25
KCV003	15-20 VICTORIAN END CAP INC CLIP	P16	LFF001	SADDLE FLASHING	P37
KCV004	25-30 VICTORIAN END CAP INC CLIP	P16	LFF001/15L/R	L/R STEPPED UNITS 10-15.9°	P37
KDE001	RIDGE DIE CAST END	P16	LFF001/20L/R	L/R STEPPED UNITS 16-20.9°	P37
KDH001L	HALF RIDGE DIE CAST END (LEFT)	P16	LFF001/25L/R	L/R STEPPED UNITS 21-25.9°	P37
KDH001R	HALF RIDGE DIE CAST END (RIGHT)	P16	LFF001/30L/R	L/R STEPPED UNITS 26-30.9°	P37
KDS001	FULL RIDGE DIE CAST END & TBRK RIDGE	P16	LFF001/35L/R	L/R STEPPED UNITS 31-35°	P37
KDS002	HALF RIDGE DIE CAST END UPPER SCREW	P16	LFF057	HORIZONTAL FLASHING 570MM	P37
KDS003	HALF RIDGE ADAPTOR PLATE LOWER SCREWS	P16	LFF0901	INTERNAL 90° CORNER FLASHING	P37
KFD001	GEORGIAN CAP FINIAL DISK	P16	LFS200	CONSERVAFLASH SOAKER 2M	P38
KFEC015	SLOTTED END 15° SMALL RAD	P17	LFS250	CONSERVAFLASH SOAKER 2.5M	P38
KFEC020	SLOTTED END 20° SMALL RAD	P17	LFS300	CONSERVAFLASH SOAKER 3M	P38
KFEC025	SLOTTED END 25° SMALL RAD	P17	LFS400	CONSERVAFLASH SOAKER 4M	P38
KFEC030	SLOTTED END 30° SMALL RAD	P17	LFS600	CONSERVAFLASH SOAKER 6M	P38
KFEC035	SLOTTED END 35° SMALL RAD	P17	LHE600	LANTERN HEADER BEAM	P6
KFEC040	SLOTTED END 40° SMALL RAD	P17	LHE600W/1	LANTERN FASICA	P6
KFKA001/1	RADIUS END FIXING KIT WHITE	P16	LHE600W/2	LANTERN TOP CLOAKING	P6
KFSB001	RIDGE END FOAM	P16	LSL001	LONG SPEEDLOCK 2 ASSEMBLY	P25
KFSC015	SLOTTED END 15° LARGE RAD	P17	LPCD001	CORNICE SEALING DAM (JOINT/ENT)	P6
KFSC020	SLOTTED END 20° LARGE RAD	P17	LPCD090	CRONICE SEALING DAM (MITRED JOINT)	P6
KFSC025	SLOTTED END 25° LARGE RAD	P17	LPCG015	CORNICE EAVES SEALING FOAM	P6
KFSC030	SLOTTED END 30° LARGE RAD	P17	LPCP001	PRESTIGE CORNICE END PLATE	P6
KFSC035	SLOTTED END 35° LARGE RAD	P17	LPCP002	PRESTIGE INLINE OUTLET COVER	P6
KFSC040	SLOTTED END 40° LARGE RAD	P17	LPLL240 FKIT	2.4M LIGHTBOARD	P38
KFT001	RIDGE FLASHING TRIM	P17	LPLL120 FKIT	1.2M LIGHTBOARD	P38
KGEA001	GABLE END CAP COMPLETE	P17	LPLL240 HKIT	2.4M LIGHTBOARD	P38
KGR001	GEORGIAN SEP END COVER SMALL	P17	LPLL120 HKIT	1.2M LIGHTBOARD	P38
KGR002	GEORGIAN SEP END COVER LARGE	P17			

Index

CODE	DESCRIPTION	PAGE	CODE	DESCRIPTION	PAGE
LPSP450/1	PRESTIGE SHELF PIERCED	P6	RWP001	RAINWATER PIPE BRANCH	P34
LPSP450/2	PRESTIGE SHELF UN-PIERCED	P6	RWP250	RAINWATER PIPE 2.5M	P34
LPSP001	PRESTIGE SHELF CHANNEL PIERCED	P6	SAB001	BOX GUTTER STRAP BOLT M8 X 80MM	P7
LVCC001	ALUMINIUM TOP CAPPINGS FIXING CLIP	P25	SAB002	BOX GUTTER STRAP BOLT M6 X 65MM	P7
LVLA001	EYEBALL SPOTLIGHT (BRASS), WHITE COLLAR	P38	SARC600	RIDGE BOLSTER	P19
LVLA001B	EYEBALL SPOTLIGHT (BRASS), BROWN COLLAR	P38	SBB001	STARTER BAR FIXING BRACKET	P26
LVLA001CB	EYEBALL SPOTLIGHT (CHROME), BROWN COLL	P38	SCN---	LOWER CORNICE SECTION	P7
LVLA001CW	EYEBALL SPOTLIGHT (CHROME), WHITE COLL	P38	SEBA600/1	STRUCTURAL EAVES BEAM 6M	P7
LWH001	LONG SPEEDLOK 2 WEATHERING HOOD	P25	SEB001	SPLICE PLATE - STRUCTURAL EAVES BEAM	P7
MBBA550/1	ALUMINIUM BOLSTER BAR	P26	SEB002L	EAVES END CAP LEFT	P7
MBB550/2	BOLSTER PVC CLADDING (FEMALE)	P26	SEB002R	EAVES END CAP RIGHT	P7
MBB550/3	BOLSTER PVC CLADDING (MALE)	P26	SEB003L	FASCIA INLINE JOINT LEFT	P7
MEA001	GUTTER 4LT EXTERNAL 90 DEG	P32	SEB003R	FASCIA INLINE JOINT RIGHT	P7
MGB002	4LT SCREW ON GUTTER BRACKET	P32	SEB550WW/3	BOLSTER MADE CLADDING	P7
MGBB001	EAVES BEAM GUTTER BRACKET	P33	SES001	90° BUTTERFLY STRAP	P7
MGO001	SPECIAL GUTTER OUTLET/TANK FITTING	P33	SES002	INLINE CLEAT	P8
MGU400	GUTTER 4LT 4M	P33	SES003	INLINE CLEAT (WITH TRANSOM)	P8
MGU600	GUTTER 4LT 6M	P33	SES004	135° BUTTERFLY STRAP	P8
MGU135	GUTTER 4LT 135 DEG ANGLE	P33	SES005L/R	165 BOX GUTTER STRAP	P8
MGU150	GUTTER 4LT 150 DEG ANGLE	P33	SES006L/R	265 BOX GUTTER STRAP	P8
MIA001	GUTTER 4LT INT 90 DEG ANGLE	P23	SEWC001L/R	ALUMINIUM EAVES MOULDING	P8
MJB001	GUTTER 4LT JOINT BRACKET	P33	SFB600	DEC SELECT FASCIA BOARD	P8
MMBB001	ROOF VENT MOUNTING BRACKET	P38	SFI003G		P8
MRIA001	INLINE RUNNING OUTLET	P33	SFI003K		P8
MRO001	RUNNING OUTLET (WALL MOUNTED)	P33	SFI003	TAPESTRY	P8
MRSA001	STOPEND OUTLET LEFT	P33	SFS001	M6 X 16 TAPTITE- SPLICE PLATE	P8
MRSA002	STOPEND OUTLET RIGHT	P33	SFS001	SPEEDLOK 2 FIXING SCREW	P26
MSE001	GUTTER STOP END LEFT	P33	SFNA004	CORONET FINIAL	P16
MSE002	GUTTER STOP END RIGHT	P33	SGHW001	SLOTTED END WASHER M6 X 20MM	P8
MSO001	GUTTER STOP END OUTLET LEFT	P33	SGRK001	REINFORCED GEORGIAN RIDGE FIXING KIT	P8
MSO002	GUTTER STOP END OUTLET RIGHT	P33	SHI001L	VIC SMALL INT RAD END COVER H/R	P20
NCGS001B	MS POLYMER SEALANT	P38	SHI00LR	VIC SMALL INT RAD END COVER H/R	P20
NVB600	VALLET BARB 6M	P29	SHI002L	VIC LARGE INT RAD END COVER H/R	P20
NVC600	VALLEY CENTRAL CONNECTOR 6M	P29	SHI002R	VIC LARGE INT RAD END COVER H/R	P20
NVDA600	VALLEY DRIP PROFILE 6M	P29	SHI003L	GEOR SMALL INT RAD END COVER H/R	P20
NVE002	VALLEY END CAP/ FIXING KIT (4M/6M)	P29	SHI003R	GEOR SMALL INT RAD END COVER H/R	P20
NVHB600/1	VALLEY WING 6M	P29	SHI004L	GEOR LARGE INT RAD END COVER H/R	P20
NVTA600	VALLEY TOP CAP 6M	P29	SHI004R	GEOR LARGE INT RAD END COVER H/R	P20
NVU600V	VALLEY UNDERCLADDING 6M WHITE	P29	SHI010/1	ROSE FIXING PLATE ASSEMBLY	P20
OET090L/R	90 DEG GUTTER TRUCK OUTLET	P33	SHI010/2	NYLON WASHER NUT	P20
PBSB030	165 BOX GUTTER JOINTING SLEEVE	P34	SHBC001S	SINGLE BOLT 21.5MM LONG	P8
PCFA635	END PROFILE TRIM (35MM) 6M	P6	SHBC001SL	SINGLE BOLT 30MM LONG	P8
PCFC604	END PROFILE TRIM (24/25MM) 6M	P6	SHBC001T	TWIN BOLT ASSEMBLY 21.5MM LONG	P8
PFCA001	JOINT INLINE	P6	SHBC001S	SINGLE BOLT 21.5 & NUT (BAG OF 50)	P8
PFCA090E	90 DEG EXTERNAL	P6	SKRA002	ROOF T SPANNERS 10MM OR 13MM	P9
PFCA290V	90 DEG INTERNAL CORNER	P6	SLH002	HUB WEATHERING SHIELD	P20
PFCA150	150 DEG INTERNAL CORNER	P6	SLH004	SPEEDLOK HUB 1/4 ADAPTOR	P20
PFCA135V	135 DEG INTERNAL CORNER	P6	SLH005	TIE BAR/ BRACKET FOR INT RAD FIX	P20
PFTB600V	FASCIA CLADDING 6M	P6	SLH006	FULL WOK WEATHERING SHIELD	P20
PMB300/1	MUNTIN BAR (TOP SECTION)	P38	SLH007	QUARTER WOK WEATHERING SHIELD	P20
PMB300/2	MUNTIN BAR (BOTTOM SECTION)	P38	SLH008	3/4 'L' WEATHERING SHIELD	P20
PRV001-24	ROOF VENT 24MM UPTO 800 X 800	P38	SLH009	FULL WOK DIE CAST END	P20
PRV002-24	ROOF VENT 24MM OVER 800 X 800	P38	SLH010	3/4 WOK DIE CAST END	P20
PRV001-35	ROOF VENT 35MM UPTO 800 X 800	P38	SLH011	1/2 WOK DIE CAST END	P20
PRV002-35	ROOF VENT 35MM OVER 800 X 800	P38	SLH012	1/4 WOK DIE CAST END	P20
PSF004	PIKESTAFF FINIAL	P19	SLH013	3/4 WOK WEATHERING SHIELD	P20
PST003	TRIM 1600MM PUNCHED	P6	SLH014	1/2 WOK WEATHERING SHIELD	P20
PST004	TRIM 950MM PUNCHED	P6	SLH015	1/2 RIDGE L SHAPE HUB SUPPORT BRACKET	P20
PSUB600	SUPPORT TRIM 6M	P6	SLHA001	SPEEDLOK HUB	P20
PVSB---	ROOF VENT BEAD	P39	SLHA001L	SPEEDLOK HALF RIDGE HUB	P20
PWLA600/1	LEAN TO WALL PLATE BODY	P19	SLHA001R	SPEEDLOK HALF RIDGE HUB	P20
RAP001	CAST RIDGE ADAPTOR 25°-30°	P19	SLHA003	SPEEDLOK EXT CORNER DIE CAST	P20
RAP002	CAST RIDGE ADAPTOR 15°-20°, 35°	P19	SNP600	DECORATIVE ULTRASELECT PLAIN FASCIA	P9
RAP003	CAST RIDGE ADAPTOR 40°	P19	SPE600L/1	LIGHT STARTER BAR 6M	P26
RCS001	RIDGE CARRIAGE SCREWS 4.2 X 13MM	P19	SPE600M/1	STARTER GLAZING BAR (78) 6M	P26
RCS001	DROP ROD BRACKET SCREW 4.2 X 13	P7	SPGA600L/1	LIGHT GEORGIAN HIP BAR 6M	P26
RCS002	HALF RIDGE WING TO MAIN BODY 4.2 X 10MM	P19	SPGC600/1	GEORG HIP GLAZING BAR (78MM) 6M	P26
RDB001	ADJUSTABLE DOWNPIPE BRACKET (RWP)	P34	SPT600L/1	LIGHT TRANS/VIC GLAZING BAR 6M	P26
RDP068	PIPE 67° OBTUSE BEND ROUND	P34	SPT600M/1	MEDIUM TRANS/VIC GLAZING BAR 6M	P27
RECA001	GLAZING BAR END CAP- TRANSOM/ HIP	P26	SPTA600/1	TRANSOM GLAZING BAR (78MM) 6M	P27
RECA001L	STARTER END CAP (MOTIF) LEFT	P26	SRGB600	GEORGIAN STRUCTURAL REINFORCEMENT 6M	P27
RECA001R	STARTER END CAP (MOTIF) RIGHT	P26	SRTB600	TRANSOM STRUCTURAL REINFORCEMENT 6M	P27
RECB002L	LEAN-TO & GABLE END CAP (MOTIF) LEFT	P26	SSA001	SPEEDLOK 2 SOCKET ASSEMBLY	P20 & 27
RECB002R	LEAN-TO & GABLE END CAP (MOTIF) RIGHT	P26	SSC001	SPEEDLOK HOUSING SPACER	P20 & 27
RES001	GABLE EAV CORNER SCREW 3.9 X 16	P7	SSF001	LANTERN CLEAT SCREW 6.3 X 19	P9
RKH001	RIDGE HANGER KIT	P19	SSG001	INLINE TRUCK OUTLET	P34
RS3510	M6 X 20MM BOLT FOR LOW PITCH EAVES ONLY	P7	SSG002	STOP END TRUCK OUTLET L & R	P34
RVA024	ROOF VENT PACKER	P39	SSL001	SHORT SPEEDLOK 2 ASSEMBLY	P20 & 27
RVDA---	ROOF VENT BOLSTER CLADDING	P39	SSPC600	LANTERN BEAM INTERNAL CLADDING	P9
RVR---	ALUMINIUM ROOF VENT BOLSTER	P39	SSRK001	REINFORCED STANDARD RIDGE FIXING KIT	P9
RVS---	MANUAL WINDER BRACKET	P39	SWH001	WEATHERING HOOD SHORT	P27
RVS001	BRACKET SCREW 4.8 X 19	P39	TBBB001	TIE BAR BRACKET AND BOLT COVERS	P39
RVSA002	STRUT/SLEEVE SCREW 4.8 X 32	P7	TBC200	TIE BAR CONDUIT 2M	P39
RVSA002	BOLSTER SCREW 4.8 X 32	P39	TBC300	TIE BAR CONDUIT 3M	P39
RVSA013	RE-INFORCING SCREW M4 X 13	P39	TBW002	WASHER USED WITH SHBC001SL)	P9
RWB001	OFFSET BEND KIT	P34	TCAC500	ANCHOR CLIP (PACK OF 500)	P27
RWO001	PIPE 67° OBTUSE BEND SQUARE	P34	TCAD001	ROUTER BIT FOR ANCHOR CLIPS	P27
RWO087	PIPE 87° OBTUSE BEND SQUARE	P34	TCAJ001	JIG FOR ANCHOR CLIPS	P27

Index

CODE	DESCRIPTION	PAGE	CODE	DESCRIPTION	PAGE
TCCA090	LANTERN HEADER CLEAT 90°	P9			
TCCA135	LANTERN HEADER CLEAT 135°	P9			
TCAC500	ANCHOR CLIP (PACK OF 500)	P27			
TCAD001	ROUTER BIT FOR ANCHOR CLIPS	P27			
TCAJ001	JIG FOR ANCHOR CLIPS	P27			
TCCA090	LANTERN HEADER CLEAT 90°	P9			
TCCA135	LANTERN HEADER CLEAT 135°	P9			
TFC400	LANTERN HEADER BEAM CLADDING	P9			
TFKA003	3 WAY TIE BAR FIXING KIT	P39			
TFKA005	5 WAY TIE BAR FIXING KIT	P39			
TFR200	THREADED FIXING ROSE	P20			
TFA001	TIE BAR BRACKET BOLT 24MM AND NUT	P39			
THD001	10MM T BAR SPANNER	P39			
THD002	13MM T BAR SPANNER	P39			
TTB200	TIE BAR THREADED BAR 2M	P39			
TTB300	TIE BAR THREADED BAR 3M	P39			
TWR001	WOK THREADED FIXING ROSE 100MM	P20			
TWR001L	WOK THREADED FIXING ROSE 150MM	P20			
UFG002/1	ELEVATED FRONT BOX GUTTER	P34			
UGTB600	UNDER GUTTER TRIM 6M	P9			
UOB001	OPENING BUTTON ON UNDERCLADDING	P20			
UVT004	STARTER BAR REINFORCING SCREW	P9			
UWC600/1	FLYMESH STRIP (18MM)- HALF RIDGE	P20			
UZBGF001	BUTTERFLY CLEAT SCREW 6 X 16	P9			
UZBGSB001	BOX GUTTER HANGING BRACKET	P34			
UZGU001	LOW PITCH FLOWLINE CLIP ON GUTTER BRACK	P34			
UZGU---	LOW PITCH FLOWLINE GUTTER	P34			
UZLPEB/1	LOW PITCH EAVES BEAM	P10			
UZLPEB/2	EAVES INNER BOTTOM TRIM	P10			
UZLPEB/3	EAVES EXTERNAL CLADDING	P10			
UZLPEB/4	INTERNAL FASCIA CLADDING	P10			
UZLPEJ001	SLEEVE TO JOIN INLINE EAVES	P10			
UZLPFR/1	FIRRING MAIN BODY	P10			
UZLPFR/2	FIRRING BASE (SITS ON FRAME)	P10			
UZLPFR/5	ALUMINIUM REINFORCEMENT	P10			
UZLPFR/6	STEEL REINFORCEMENT	P10			
UZRI010/5	M8 SINGLE COILED SPRING	P10			
UZRW001W/1	DOWNPIPE BRACKET PIPE CLIP	P34			
UZRW001W/2	DOWNPIPE BRACKET SOCKET CLIP	P34			
UZRW001W/3	DOWNPIPE BRACKET BACKPLATE	P34			
UZRW002	DOWNPIPE SHOE	P34			
UZRW250W	RAINWATER DOWNPIPE	P34			
UZSB003/3	STRUT BRACKET SCREW M6 X 12	P10			
VAAA600H	HEAVY MULTI EAVES BEAM 6M	P10			
VFB600PA	VICTORIAN 165MM BOX GUTTER 6M	P35			
VBLA069/1	RAD END BRUSH 7 SERIES BAR 800MM VICT	P15			
VBLA080/1	RAD END BRUSH 7 SERIES BAR 800MM GEOR	P14			
VFK001	VICTORIAN FIXING KIT	P10			
VFK002	VICTORIAN FIXING KIT	P10			
VLPB001/1	TRANSOM BAR PACKER (BLACK) (20)	P10			
VPLB002	5 WAY DROP ROD BRACKET	P10			
VPLB003	COMPRESSION STRUT BRACKET	P10			
VPLB090	LANTERN BEAM CLEAT 90°	P10			
VPLB135	LANTERN BEAM CLEAT 135°	P10			
VPLB600	VARIABLE PITCH LANTERN BEAM	P10			
VPLF010	LANTERN BAFFLE SEALING FOAM 10M	P9			
VSR001	PLASTIC SNAP RIVETS- RIDGE CAP	P20			
VRK002	VALLEY RAFTER KIT	P29			
VRK003	VALLEY RAFTER KIT STRUCTURAL	P29			
VRK004/1	EAVES MOULDING STARTER FIXING				
VWBA600/1	265MM BOX GUTTER ALUMINIUM 6M	P35			
VWBA600/3	265MM BOX GUTTER SLEEVE 6M	P35			
VWSA001	265 BOX GUTTER REINFORCEMENT STRAP	P35			
WCP001/1	WALLPLATE 5° PACKER	P20			
WCS100/35	WALLPLATE CARRIAGE 100MM	P20			
WEC001/L	WALLPLATE END CAP (LEFT)	P20			
WEC001/R	WALLPLATE END CAP (RIGHT)	P20			
WMB600/35/1	WALLPLATE MAIN BODY (5-10°)	P20			
WMB600/35/2	WALLPLATE MAIN BODY (10-15°)	P20			
WTC600/1	WALLPLATE TOP CAPPING	P20			
WUC600	INCLUDING MESH PR BUTTON	P20			
WUC600/1	WALLPLATE UNDERCLADDING INC VEST STRIP	P20			



Conservatories



Orangeries



Extensions

QUANTAL

www.quantal.co.uk

ultraframe
Transforming light and space

www.ultraframe.co.uk